

CONFIDENTIAL

DATE	REV	RECORD	DR
8/21	A	SUBMITTAL	JK

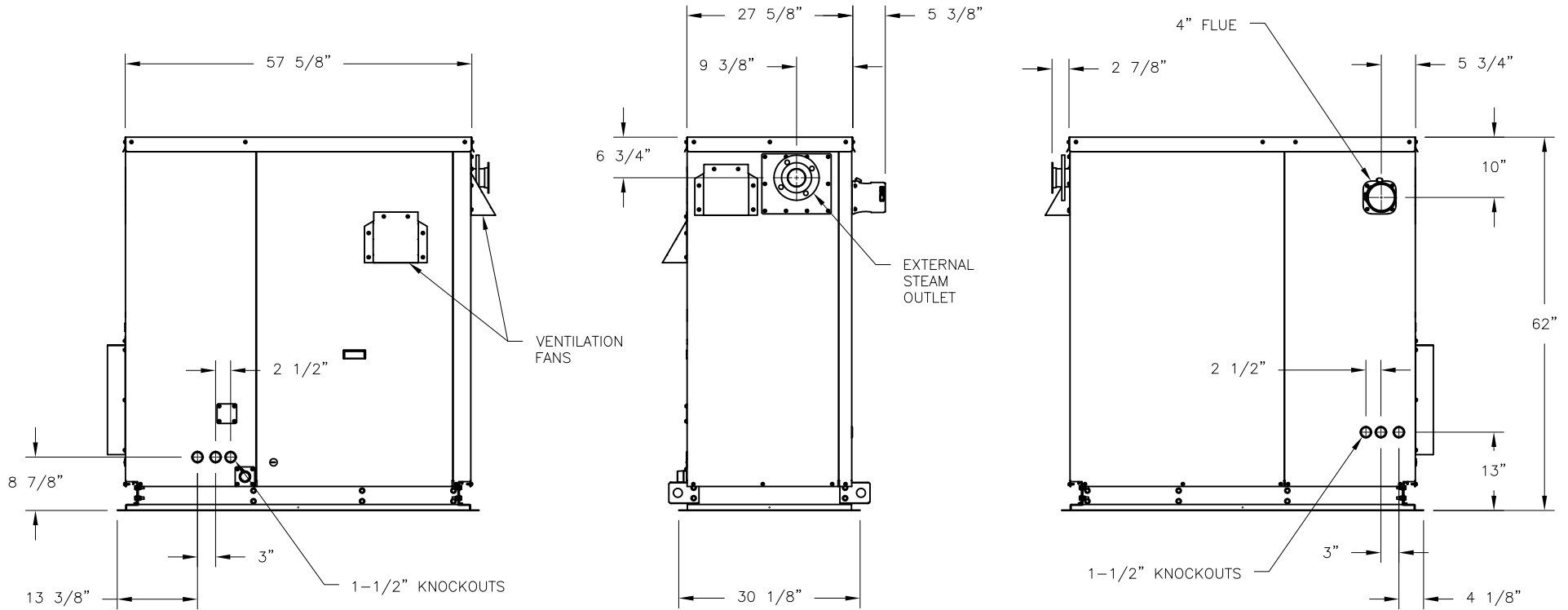

	GTS LX 200-250-300 OUTDOOR ENCLOSURE	
	MAT'L:	
	SCALE: 1:26	P/N
	DATE: 8/4/21	GENERIC SUBMITTAL