

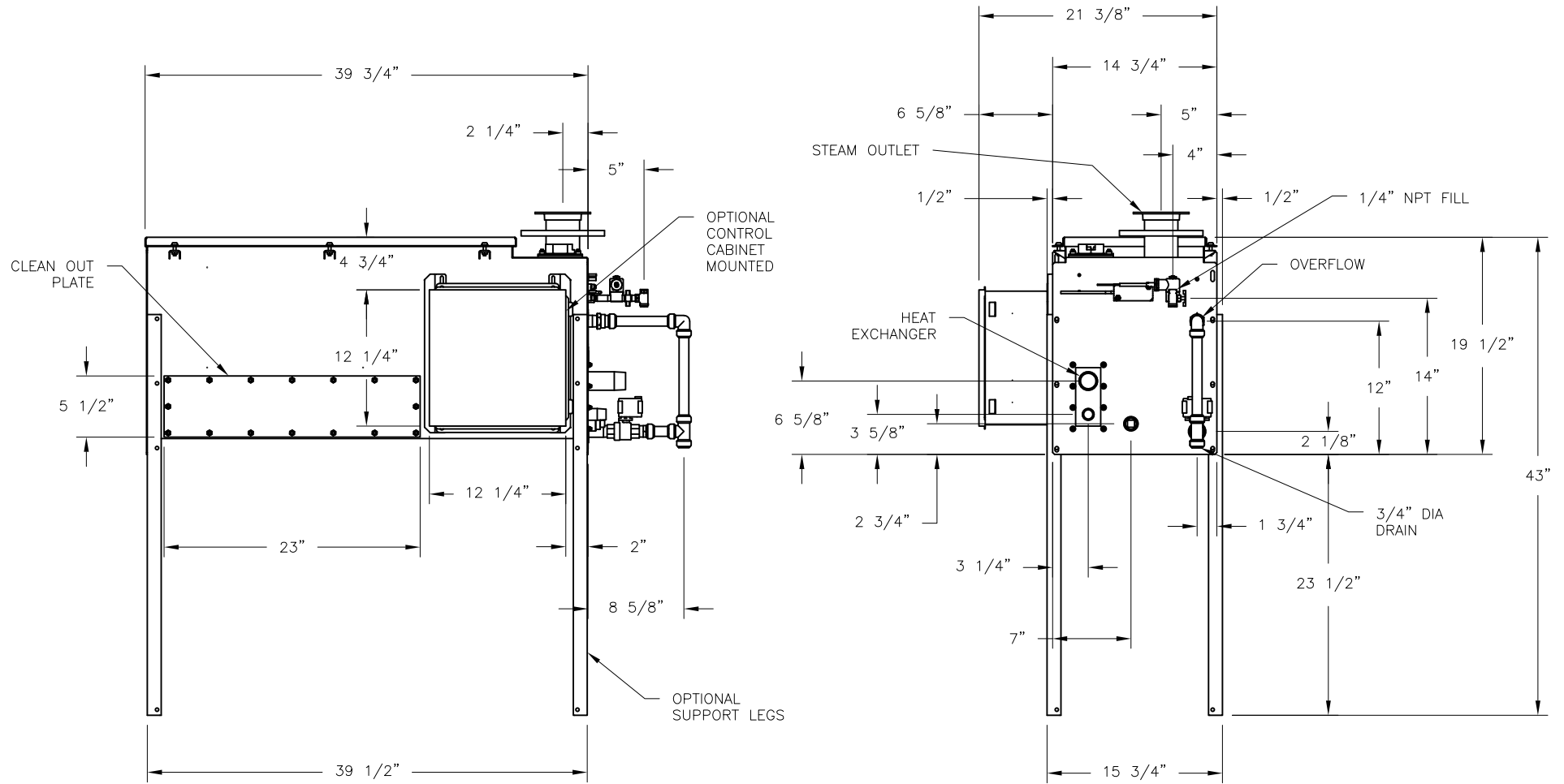

CONFIDENTIAL

DATE	REV	RECORD	DR
6/22	A	SUBMITTAL	JK
11/23	B	SUBMITTAL	AJK



		STS-50	
		MAT'L:	
SCALE: 1:14		P/N	
DRAWN BY: JK		GENERIC SUBMITTAL	
DATE: 6/14/22			