

CONFIDENTIAL

DATE	REV	RECORD	DR
8/21	A	SUBMITTAL	JK
8/21	B	SUBMITTAL	JK

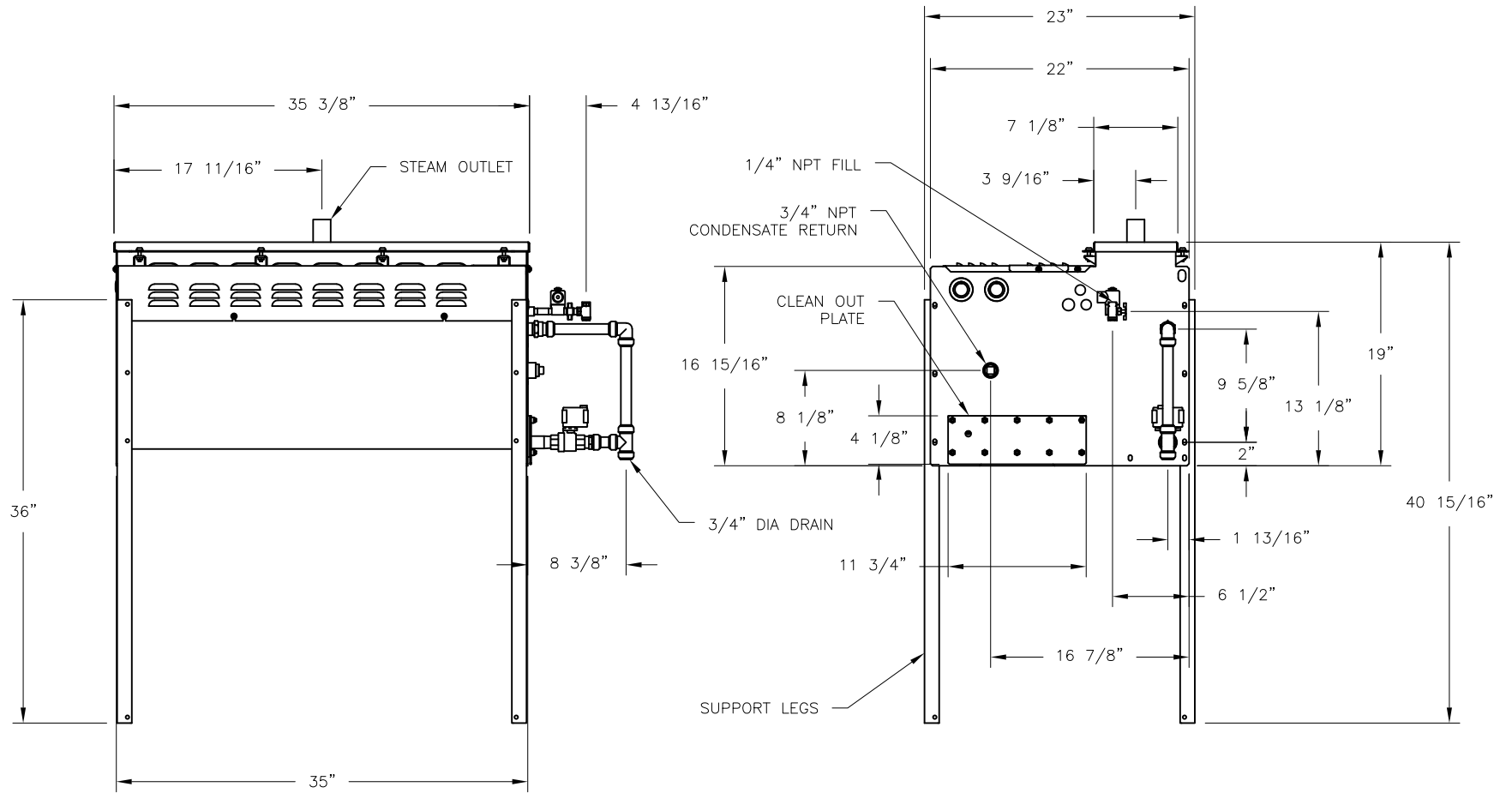

		VLC 12 HEATER	
		MAT'L:	
SCALE:	1:14	P/N	GENERIC SUBMITTAL
DRAWN BY:	JK		
DATE:	8/5/21		