

CONFIDENTIAL

DATE	REV	RECORD	DR
2/23	A	SUBMITTAL	JK

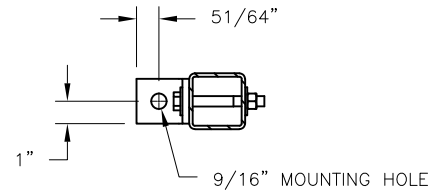

TOP VIEW OF DETAIL A

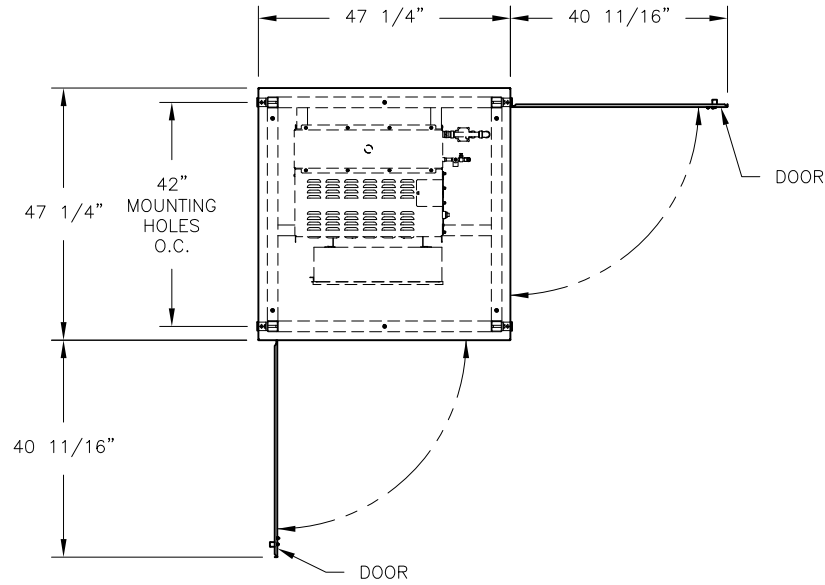
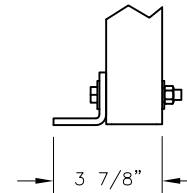

DETAIL A

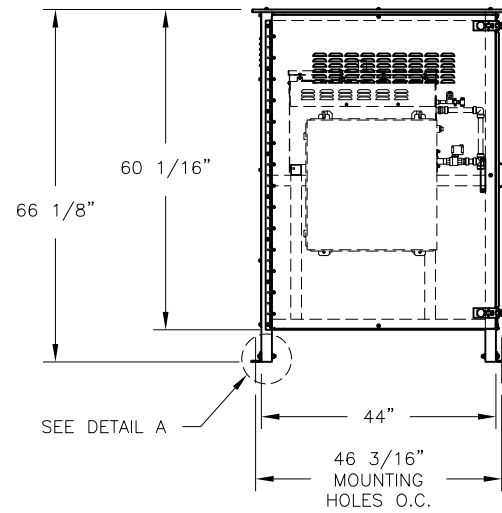
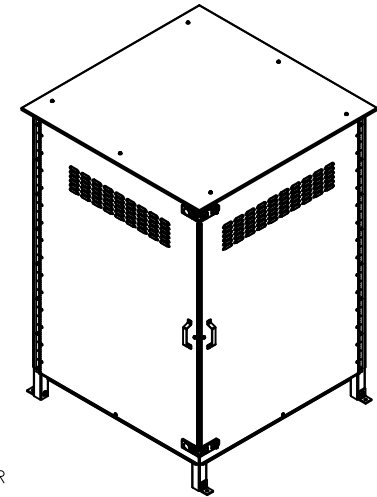

CONTROL CABINET

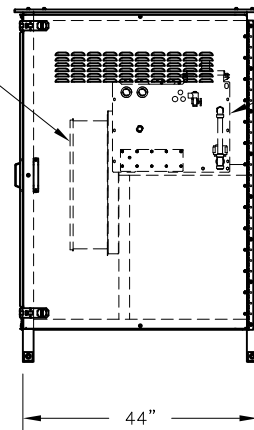

TYPICAL VLC/VLDI 9 HEATER HUMIDIFIER

		VLC 9 HEATER WEATHER COVER	
		MAT'L:	
SCALE: 1:36	P/N	GENERIC SUBMITTAL	
DRAWN BY: JK			
DATE: 2/15/23			