

CONFIDENTIAL

DATE	REV	RECORD	DR
10/22	A	SUBMITTAL	JK

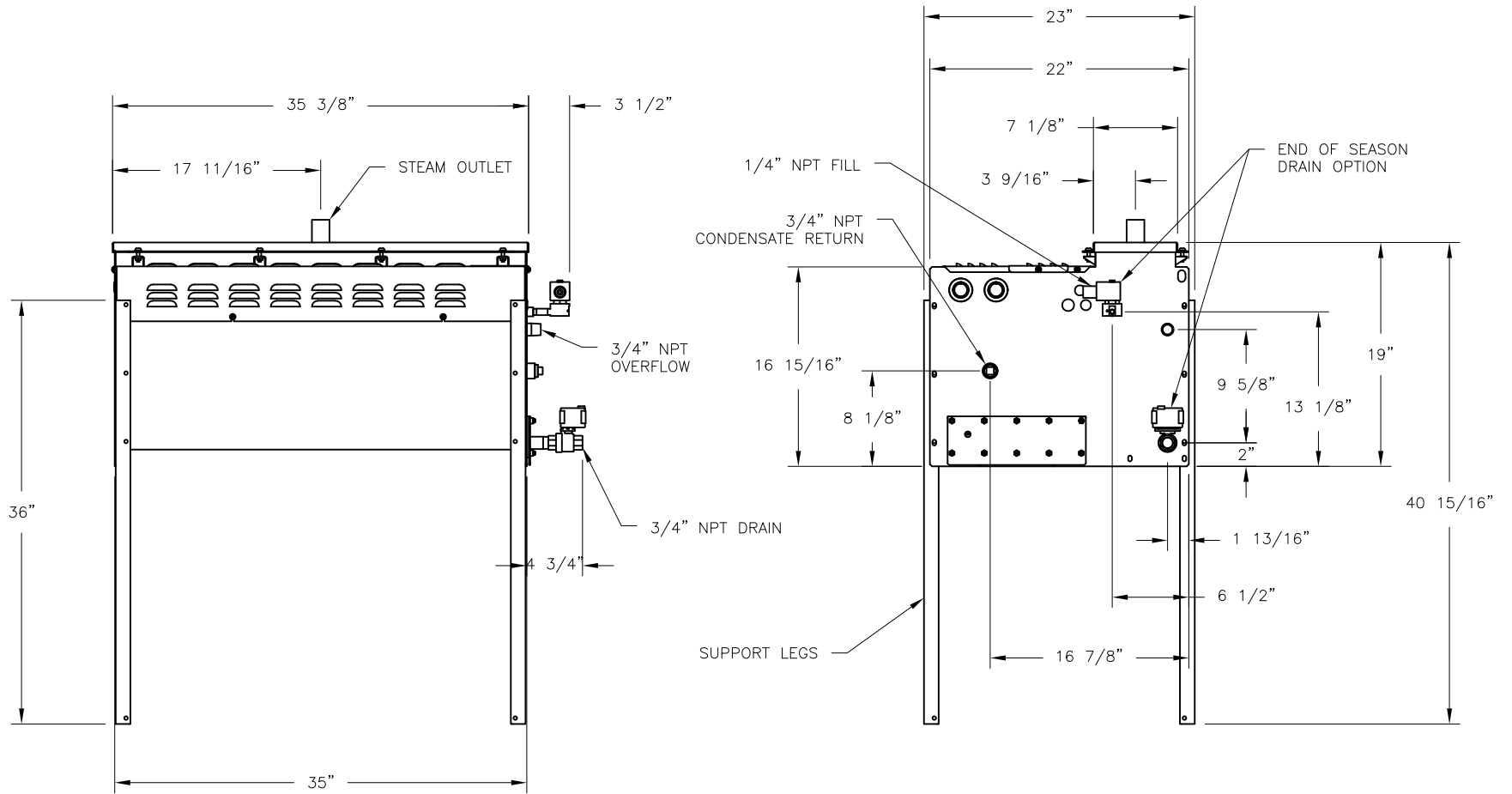

		VLDI 12 HEATER END OF SEASON DRAIN	
		MAT'L:	
SCALE:	1:14	P/N	GENERIC SUBMITTAL
DRAWN BY:	JK		
DATE:	10/3/22		