

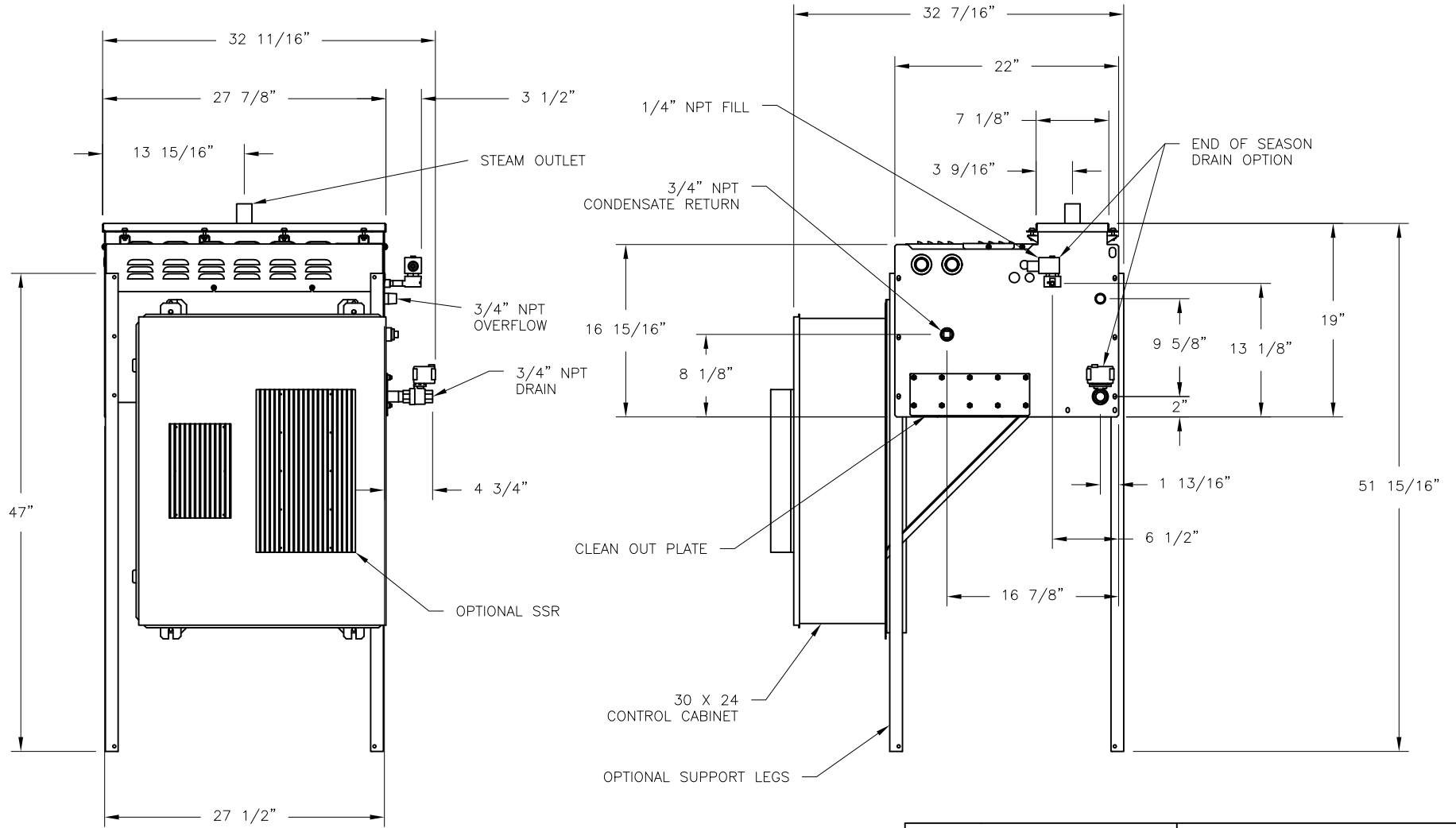

CONFIDENTIAL

DATE	REV	RECORD	DR
10/22	A	SUBMITTAL	JK



		VLDI 9 HEATER END OF SEASON DRAIN X-LARGE CABINET	
		MAT'L:	
SCALE:	1:15	P/N	
DRAWN BY:	JK	GENERIC SUBMITTAL	
DATE:	10/4/22		