

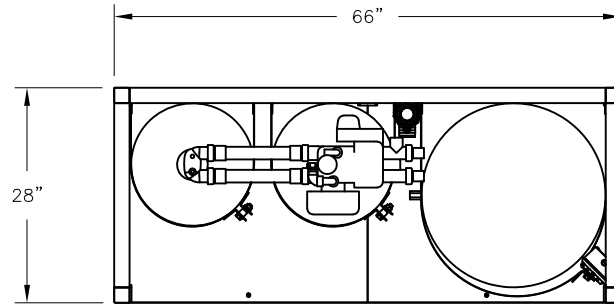

CONFIDENTIAL

DATE	REV	RECORD	DR
8/22	A	SUBMITTAL	JK

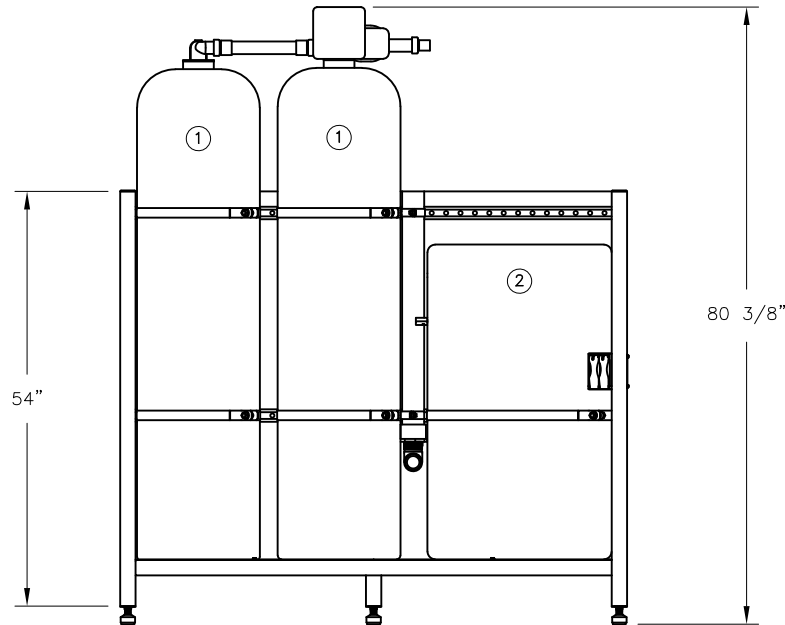

DUPLEX WATER SOFTENER AND BRINE TANK 1" NPT CONNECTIONS			
EQUIPMENT	TOTAL CAPACITY	DIMENSION	ELECTRIC SUPPLY
① RESIN TANKS (2)	8.0 CU. FT.	16"ø x 65"H EA.	120 VOLTS 5 AMP. OUTLET
② BRINE TANK		24"ø x 41"H	



		WD1665 SKID	
		MAT'L:	
		SCALE: 1:25	P/N
		DRAWN BY: JK	GENERIC SUBMITTAL
		DATE: 8/15/22	