

CONFIDENTIAL

DATE	REV	RECORD	DR
8/22	A	SUBMITTAL	JK

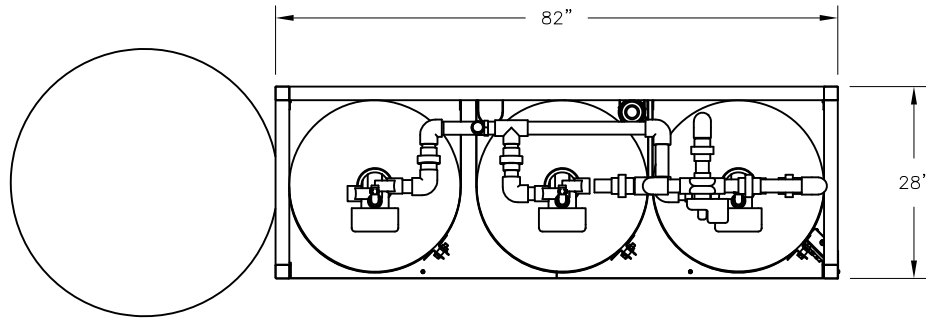

DUPLEX WATER SOFTENER AND BRINE TANK 1-1/2" NPT CONNECTIONS			
EQUIPMENT	TOTAL CAPACITY	DIMENSION	ELECTRIC SUPPLY
① RESIN TANKS (2)	16.0 CU. FT.	24"ø x 72"H EA.	120 VOLTS 5 AMP. OUTLET
② BRINE TANK		39"ø x 48"H	

③ DECHLORINATOR 1-1/2" NPT CONNECTIONS		
MODEL #	DC 2472	ELECTRIC SUPPLY
CAPACITY	8.0 CU. FT.	120 VOLTS 5 AMP. OUTLET
DIMENSION	24"ø X 72"	

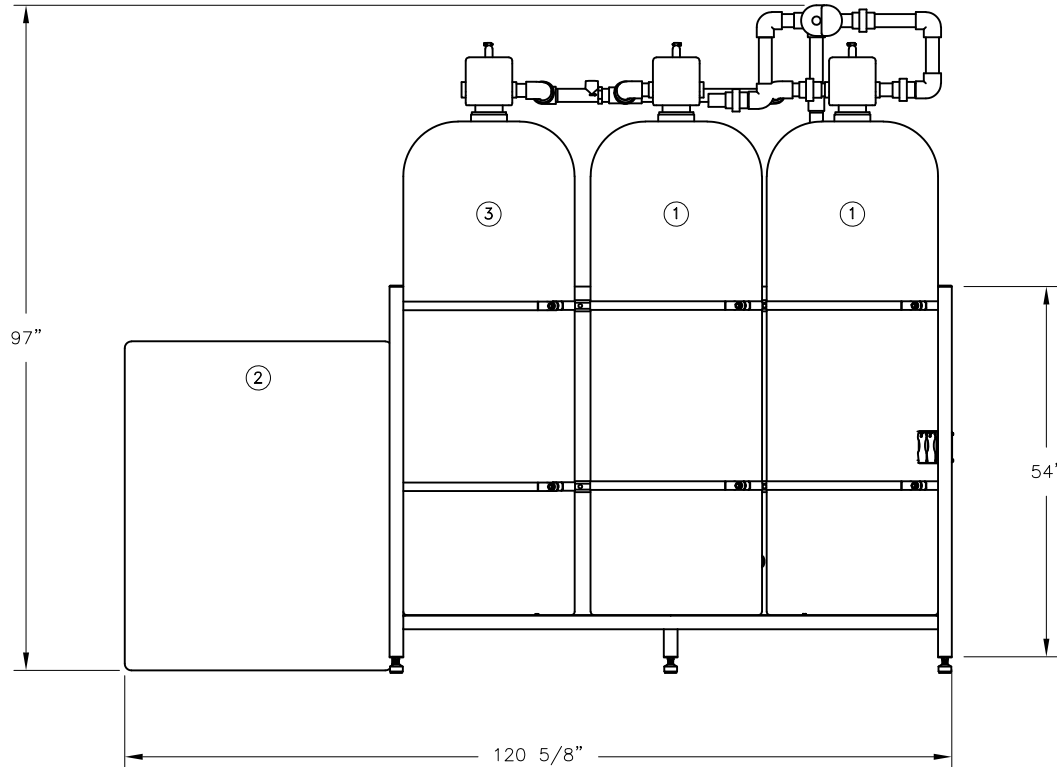

		WD2472 & DC2472 SKID	
		MAT'L:	
SCALE: 1:28		P/N	
DRAWN BY: JK		GENERIC SUBMITTAL	
DATE: 8/15/22			