

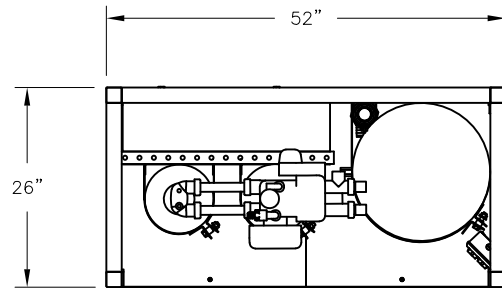

CONFIDENTIAL

DATE	REV	RECORD	DR
8/22	A	SUBMITTAL	JK

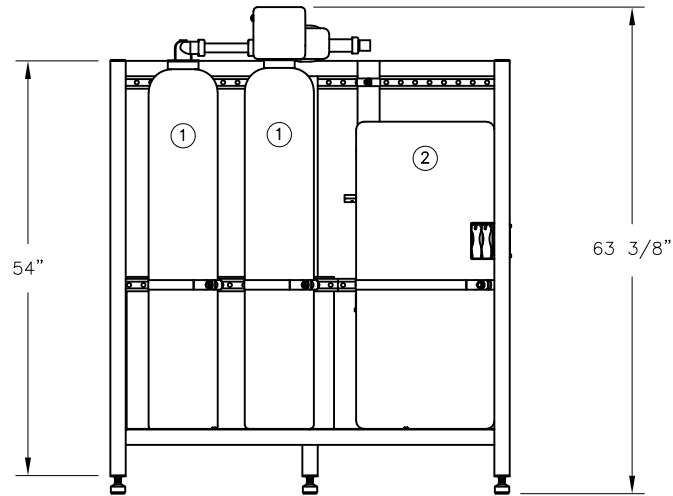

DUPLEX WATER SOFTENER AND BRINE TANK 1" NPT CONNECTIONS			
EQUIPMENT	TOTAL CAPACITY	DIMENSION	ELECTRIC SUPPLY
① RESIN TANKS (2)	2.0 CU. FT.	9"Ø x 48"H EA.	120 VOLTS 5 AMP. OUTLET
② BRINE TANK		18"Ø x 40"H	



		WD948 SKID	
		MAT'L:	
SCALE: 1:25		P/N	
DRAWN BY: JK		GENERIC SUBMITTAL	
DATE: 8/15/22			