

CONFIDENTIAL

DATE	REV	RECORD	DR
8/22	A	SUBMITTAL	JK

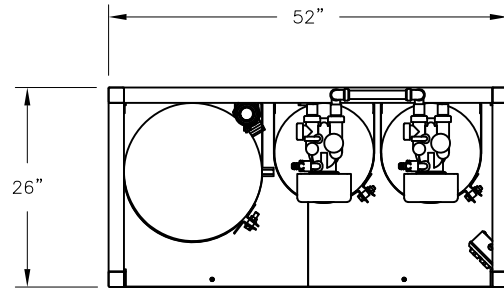

SINGLE WATER SOFTENER AND BRINE TANK 1" NPT CONNECTIONS			
EQUIPMENT	CAPACITY	DIMENSION	ELECTRIC SUPPLY
① RESIN TANK	2.5 CU. FT.	13"φ x 54"H	120 VOLTS 5 AMP. OUTLET
② BRINE TANK		18"φ x 40"H	

③ DECHLORINATOR 1" NPT CONNECTIONS		
MODEL #	DC 1354	ELECTRIC SUPPLY
CAPACITY	2.5 CU. FT.	120 VOLTS 5 AMP. OUTLET
DIMENSION	13"φ x 54"	

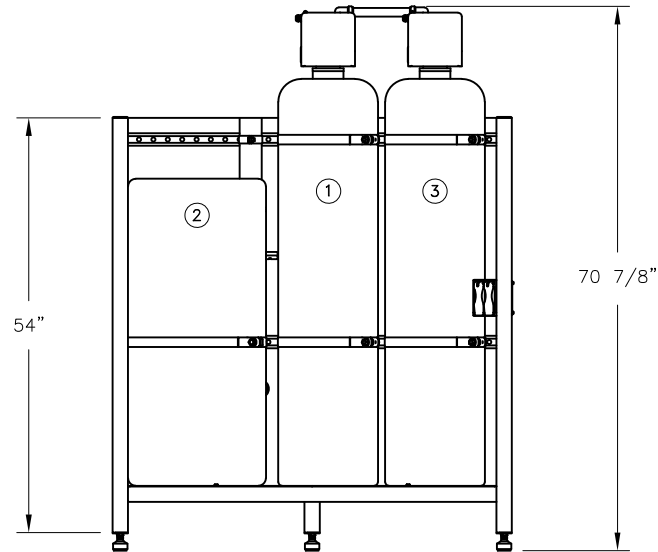

		WS1354 & DC1354 SKID	
		MAT'L:	
SCALE: 1:25		P/N	
DRAWN BY: JK		GENERIC SUBMITTAL	
DATE: 8/15/22			