

CONFIDENTIAL

DATE	REV	RECORD	DR
8/22	A	SUBMITTAL	JK

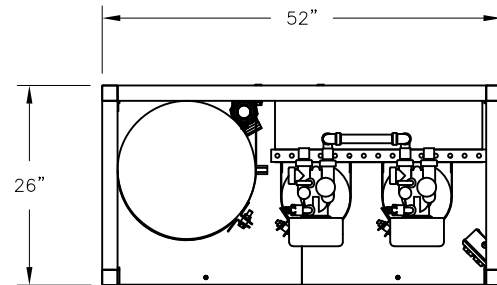

SINGLE WATER SOFTENER AND BRINE TANK 1" NPT CONNECTIONS			
EQUIPMENT	CAPACITY	DIMENSION	ELECTRIC SUPPLY
① RESIN TANK	1.0 CU. FT.	9"ø x 48"H	120 VOLTS 5 AMP. OUTLET
② BRINE TANK		18"ø x 40"H	

③ DECHLORINATOR 1" NPT CONNECTIONS		
MODEL #	DC 948	ELECTRIC SUPPLY
CAPACITY	1.0 CU. FT.	120 VOLTS 5 AMP. OUTLET
DIMENSION	9"ø x 48"	

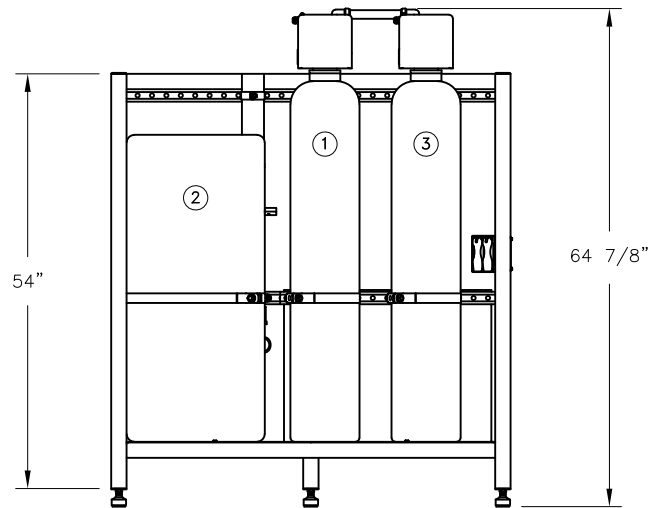

		WS948 & DC948 SKID	
		MAT'L:	
SCALE: 1:25		P/N	
DRAWN BY: JK		GENERIC SUBMITTAL	
DATE: 8/15/22			