

Important: Read and save these instructions.

Vapor-logic® 4

Humidifier Control System

Installation and Operation Manual

IRISTEEM[®]
The humidification experts



Contents

DRI-STEEM® Technical Support:
800-328-4447









Warnings and Cautions	iv
Overview	
Vapor-logic4 capabilities	1
Humidification system overview	3
Vapor-logic4 board:	4
Keypad/display	6
Web interface	7
Installation	
Pre-installation Checklist	8
Installation process	10
Step 1 – Field wiring:	
Control input	12
Control input signals	14
Limit controls	16
Communication connections	
Vapor-logic4 keypad/display	19
Web interface communication	21
Other communication connections	23
Sensor placement	26
Step 2 – Setup	
Using the keypad/display	28
Using the Web interface	29
Setup screen	29
Step 3 – Startup	37
Staging multiple XT humidifiers	
Control input examples	37
Setting control input ranges	37
Operation	
Using menus and screens	
Changing mode and set point	39
Tank activities defined	39
Home screen (keypad/display)	39
Status screen	40
Diagnostics screen	43
Alarms screen	48
Setup menu	50
PID tuning	
Improves humidifier response time	51
The proportional term	51
The integral term	52
The derivative term	53
PID band	53
PID setup tips	54
Water level control	
Probe system	55
Float valve system	56
Electrode steam humidifiers	57

Contents

Options and features	
Duct high limit switch option	58
Modulating high limit transmitter option	58
Temperature compensation control option	58
Auxiliary temperature sensor option	59
Tank preheat feature	59
Aquastat set point feature	60
Fan-based dispersion operation	60
Sensor offsets	61
Automatic drain sequence, tap/softened water	61
Draining when using softened water	62
Skim timer	62
End-of-season drain	62
Service interval	62
Setting date and time	63
Battery backup, nonvolatile memory	63
Security/password	63
Downloading historical data	64
Backing up and restoring data	64
Firmware updates	
Downloading firmware updates	65
Installing firmware updates	68
Test outputs and test run	69
Modbus, BACnet, LonTalk interoperability	
Connections	70
Installing LonTalk as a retrofit	70
Installing BACnet as a retrofit	70
Multiple-tank operation:	
Introduction	
Multi-tank mode defined	77
Multi-tank control interface	77
Priority groups	
Start-up order and trim tanks	77
Tank grouping to maximize efficiency	78
Redundant tank for mission-critical applications	78
Tank wear leveling	78
Fault tolerance	78
Wiring and setup	
Wiring a multi-tank group of humidifiers	80
Multi-tank system setup	80
Modbus, BACnet, LonTalk	
Multi-tank fieldbus profiles	81
Other system parameters and interoperability	81
Multi-tank operation with Web interface	81
Using the keypad/display	82
Using the Web interface	83
Troubleshooting guide	84
Replacement parts	96
Warranty	Back cover

 WARNING	CAUTION
Indicates a hazardous situation that could result in death or serious injury if instructions are not followed.	Indicates a hazardous situation that could result in damage to or destruction of property if instructions are not followed.

mc_051508_1145

 WARNING	
	<p>Read all warnings and instructions</p> <p>This page provides important safety instructions; it is intended to supplement — not replace — the humidifier's Installation, Operation, and Maintenance Manual (IOM). Read the IOM that was provided with the humidifier before performing service or maintenance procedures on any part of the system. Failure to follow all warnings and instructions could produce the hazardous situations described here and in the IOM, resulting in property damage, personal injury, or death.</p> <p>If the IOM is missing, go to www.dristeem.com to download a replacement.</p> <p><small>mc_071608_0910</small></p>
 	<p>Hot surfaces and hot water</p> <p>Steam humidification systems have extremely hot surfaces, and water in tanks, electrode cylinders, steam pipes, and dispersion assemblies can be as hot as 212 °F (100 °C). To avoid severe burns, allow the entire humidification system to cool.</p> <p>Follow the cool-down procedure in the humidifier's IOM before performing service or maintenance procedures on any part of the system.</p> <p><small>mc_071608_0911</small></p>
   	<p>Shut down the energy source</p> <p>Before performing service or maintenance procedures on any part of the humidification system, verify that all energy sources are off. Energy sources can be electricity, gas, steam, or hot liquid. Failure to shut down the energy source could result in carbon monoxide poisoning, fire, explosion, electrical shock, and other hazardous conditions. These hazardous conditions could cause property damage, personal injury, or death.</p> <p>Contact with energized circuits can cause property damage, severe personal injury or death as a result of electrical shock or fire. Do not remove the shroud/cover, electrical panel cover/door, access panels, or heater terminal cover until electrical power is disconnected.</p> <p>Follow the shutdown procedure in the humidifier's IOM before performing service or maintenance procedures on any part of the system.</p> <p><small>mc_050808_1551</small></p>

CAUTION
<p>Hot discharge water</p> <p>Discharge water can be as hot as 212 °F (100 °C) and can damage the drain plumbing.</p> <p>Humidifiers equipped with a water tempering device need fresh make-up water in order to function properly. Make sure the water supply to the water tempering device remains open during draining.</p> <p>Excessive supply water pressure</p> <p>Supply water pressure greater than 80 psi (550 kPa) can cause the humidifier to overflow.</p> <p><small>mc_011909_1140</small></p>

Vapor-logic4 capabilities

Accurate, responsive control

The Vapor-logic4 controller provides accurate, responsive RH control. PID control tunes the system for maximum performance.

Modbus[®], BACnet[®], or LonTalk[®] allow interoperability with multiple building automation systems. Modbus is standard, and BACnet or LonTalk are available options.



Web interface, provides the capability to set up, view, and adjust humidifier functions via Ethernet, either directly or remotely through a network.

Contactor wear leveling (Vaporstream[®]) distributes cycles among multiple contactors for equal wear and longer contactor life.

Cycle counter (electric humidifiers) triggers a message when it's time to replace contactors.

USB port allows easy firmware updates, and data backup and restore capability

Real-time clock allows time-stamped alarm and message tracking, and accurate drain and flush scheduling.

Auxiliary temperature sensor/transmitter allows temperature compensation control to prevent window condensation, or air temperature monitoring, such as in a duct (not available for XT humidifier).

Programmable outputs allow remote signaling and device activation.

Multiple-humidifier control allows staged control of up to 16 humidifiers with one controller.

Note: XT humidifiers do not operate in multi-tank mode; however, up to four XT humidifiers can be staged to operate in sequence.

Controller data, such as RH, air temperature, water use, energy use, alarms, and messages, can be downloaded to a PC for viewing and analysis. RH, alarms, and messages can also be viewed on the keypad/display and Web interface.

More capabilities on the next page ►

Vapor-logic4 capabilities

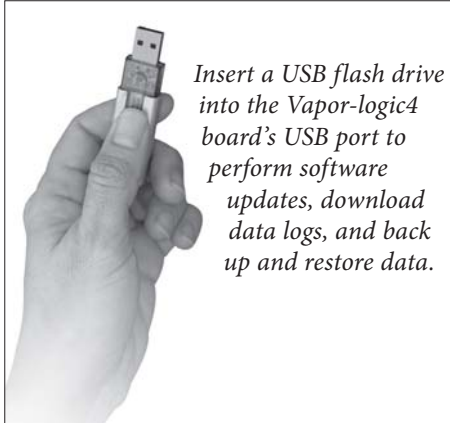

Enhanced diagnostics include:

- **Test outputs** function using keypad/display or Web interface to verify component operation
- **Test humidifier** function using simulated demand to validate performance

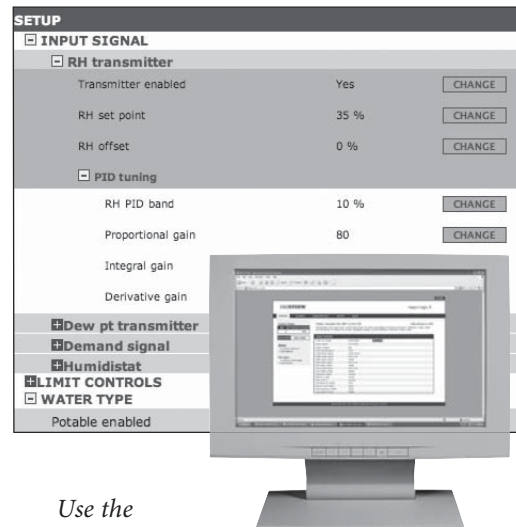

Use the Vapor-logic4 keypad/display or the standard Web interface, shown here, to control your humidification system.

Humidification system overview

Figure 3-1:
Typical humidification system layout (GTS humidifier shown)

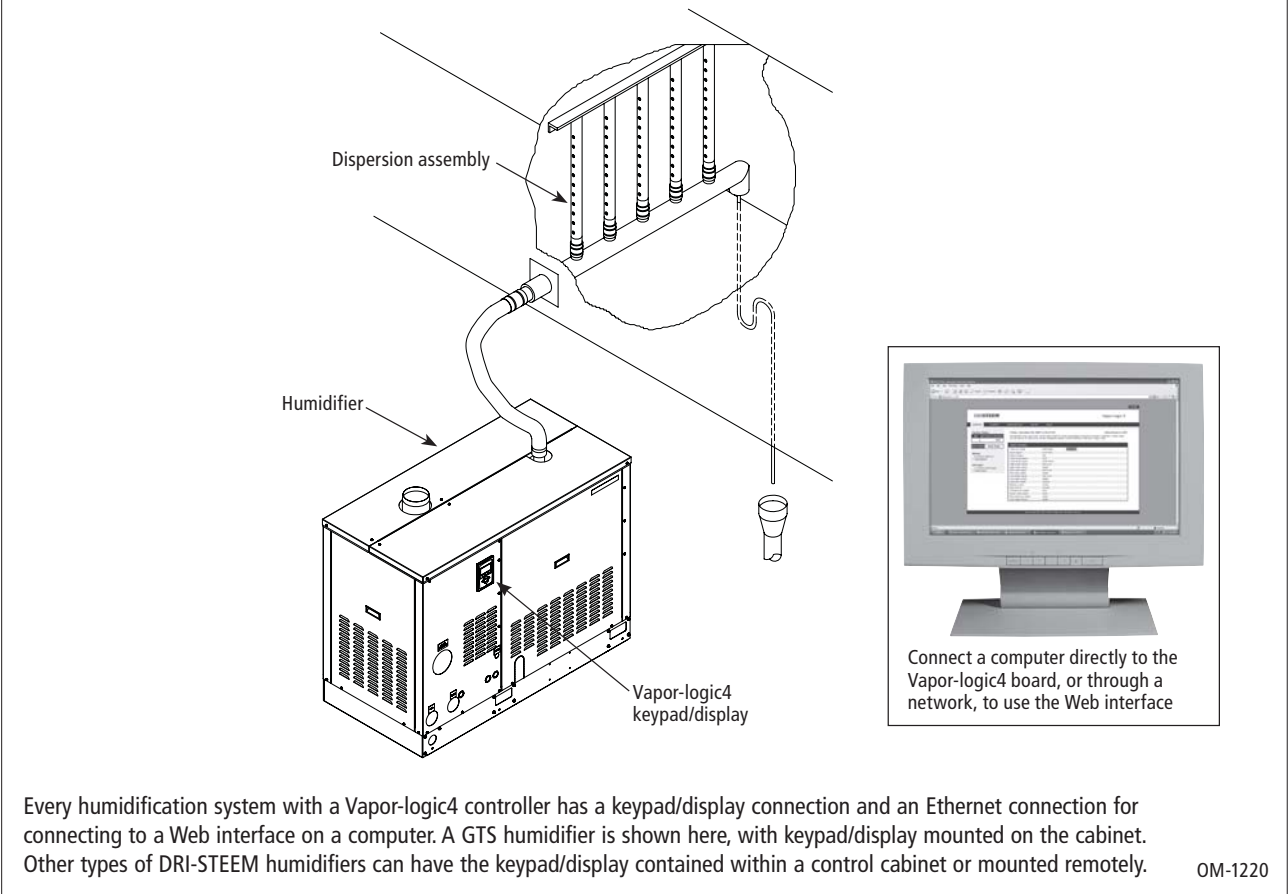

Operating conditions

The Vapor-logic4 main board and keypad/display must be operated and stored within the limits listed below. Exceeding these limits can result in poor display performance and/or damage to the unit.

Main board

- Operating temperature: 32 °F to 158 °F (0 °C to 70 °C)
- Storage temperate: -40 °F to 185 °F (-40 °C to 85 °C)
- Operating humidity range: <95% noncondensing

Keypad/display

- Operating temperature: 32 °F to 158 °F (0 °C to 70 °C)
- Storage temperate: -22 °F to 176 °F (-30 °C to 80 °C)
- Operating humidity range: <95% noncondensing

Vapor-logic4 board: Components

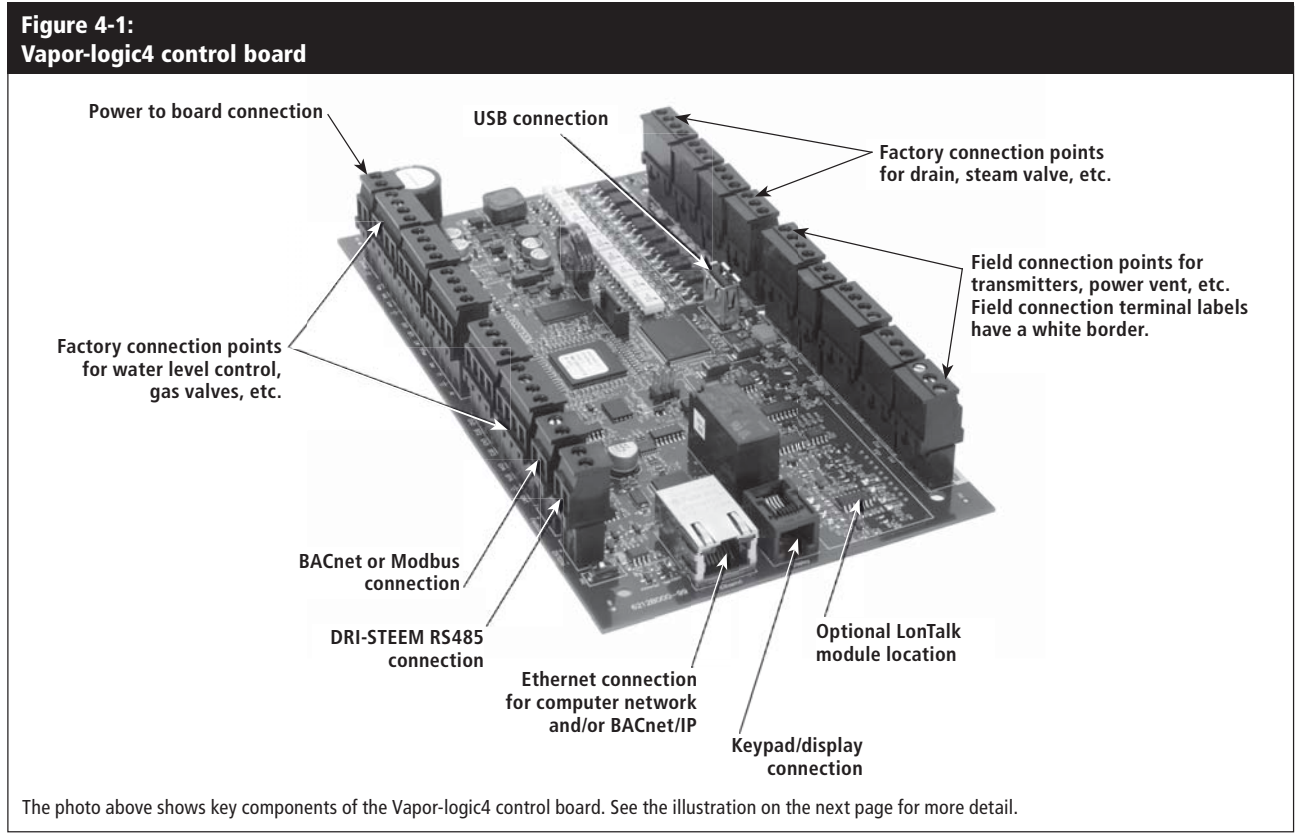

**Figure 4-2:
Control board mounted on GTS subpanel**

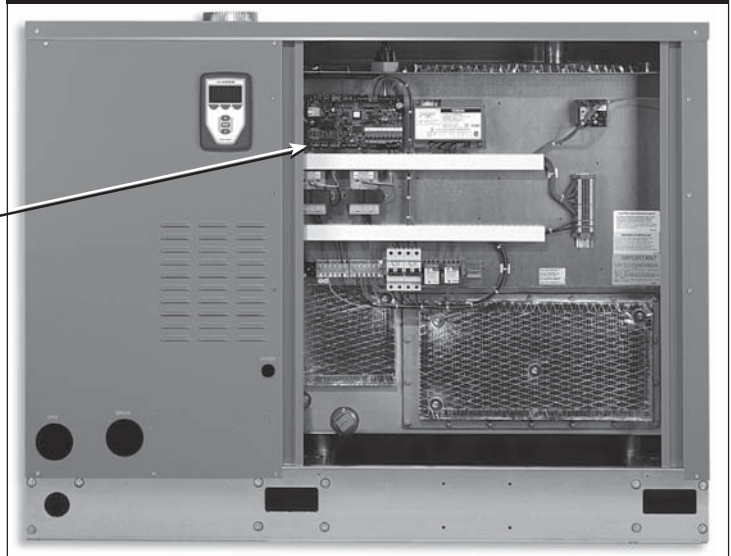

Vapor-logic4 control board

The Vapor-logic4 control board is mounted inside the humidifier control compartment or cabinet.

Notes:

- Control board is shown here mounted on a GTS humidifier subpanel. Location varies with humidifier type.
- Control board for electric humidifiers is in the control cabinet or on the humidifier's subpanel.

Vapor-logic4 board: Connections

Figure 5-1:
Vapor-logic4 control board connections

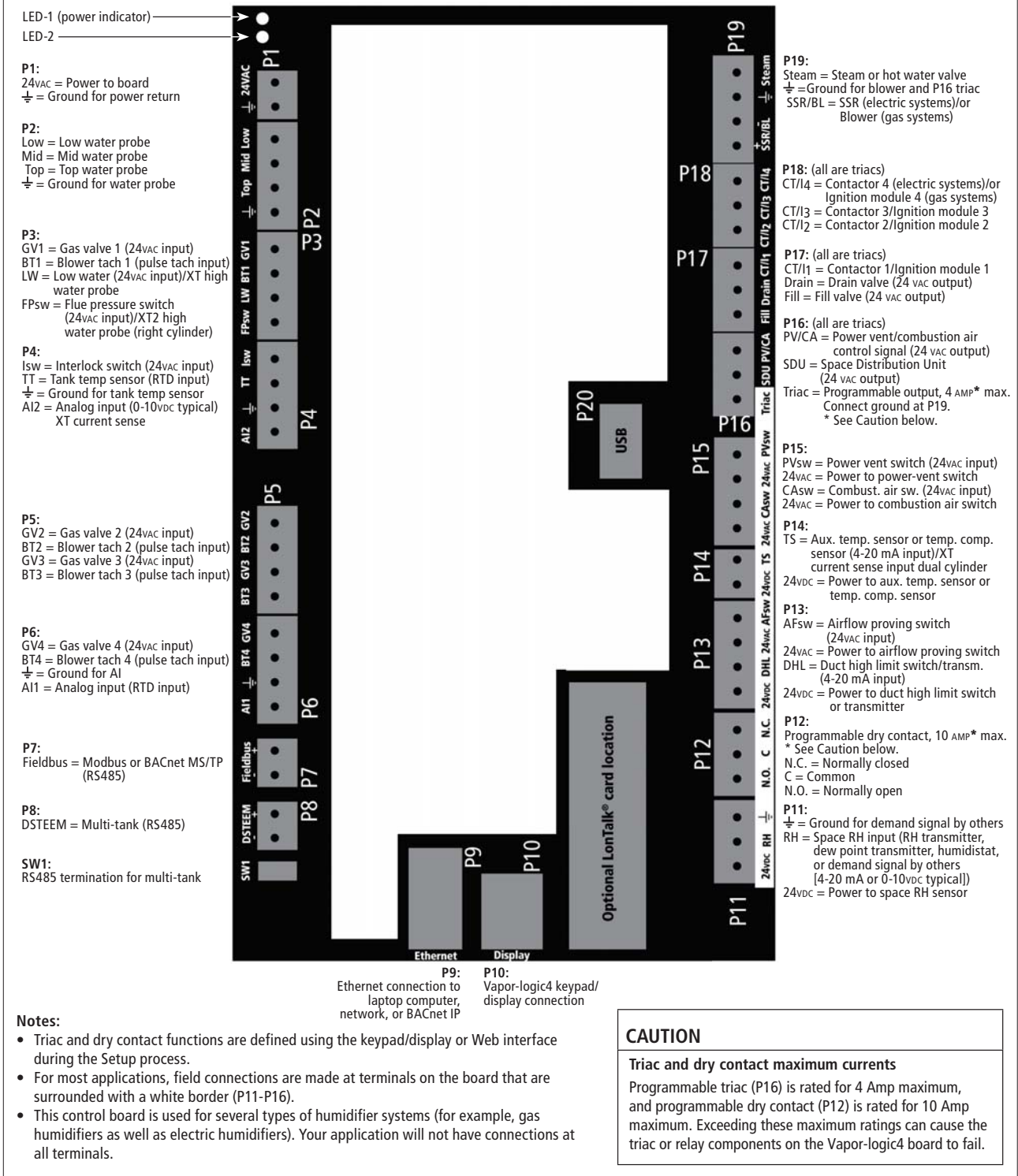

Keypad/display

Figure 6-1:
Using the Vapor-logic4 keypad/display

Typical Home screen

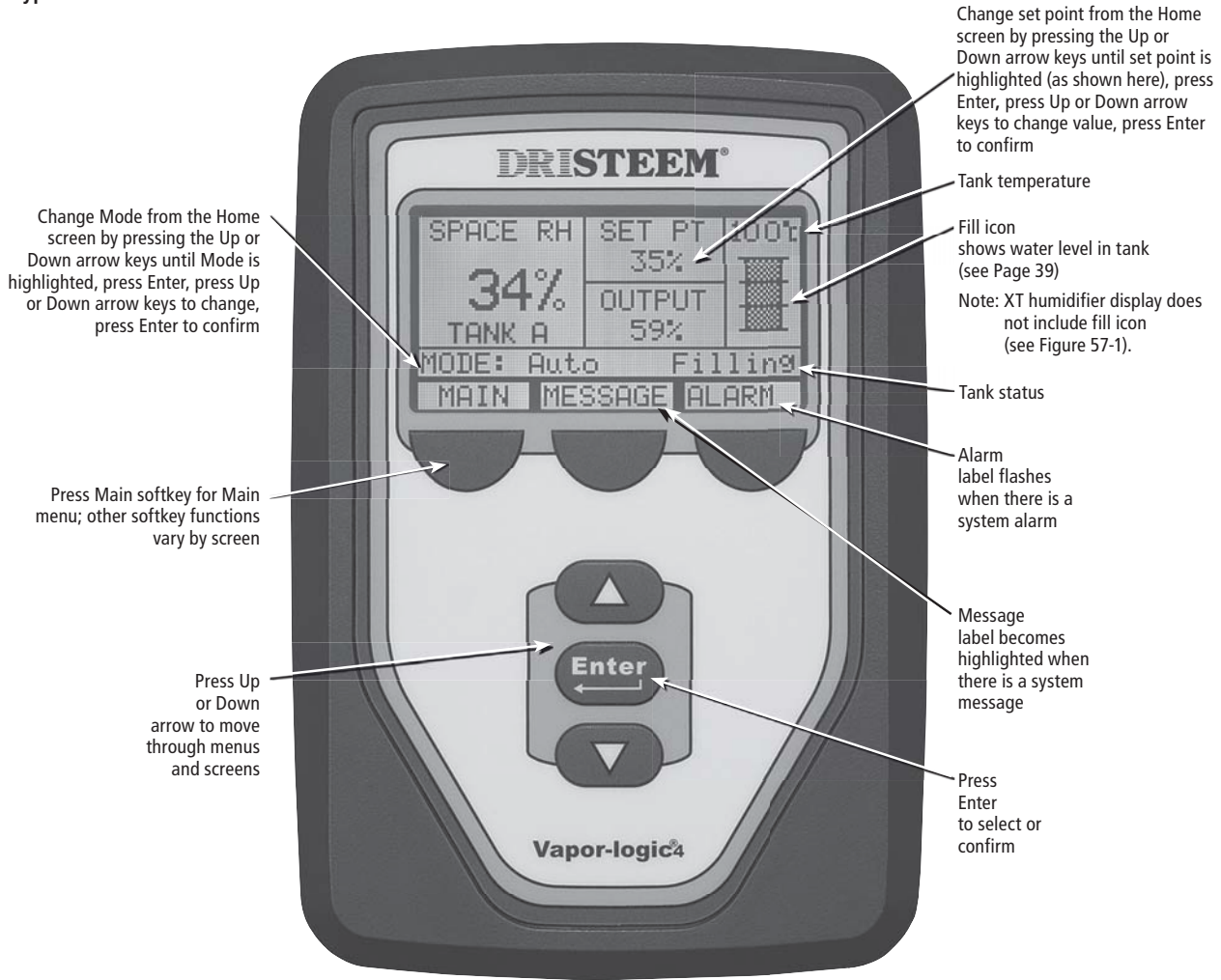

Web interface

Figure 7-1:
Using the Vapor-logic4 Web interface (Setup screen shown)

DRISTEEM Vapor-logic4

STATUS ALARMS DIAGNOSTICS **SETUP** HELP

Tuesday, November 20, 2010 12:19:51 PM Data stream is STOPPED [START LIVE DATA](#)

Set or change all humidifier settings below. Humidifiers are sent from the factory configured as ordered. However, some settings are unknown at the factory and need to be defined on this page.

System Status

SPACE RH	SET POINT	OUTPUT
58%	35%	0%

RUN MODE Local standby

TANK STATUS Warm

Alarms
0 active alarms
> [View Alarms](#)

Messages
1 active message
> [View Messages](#)

SETUP

- INPUT SIGNAL

- RH transmitter

Transmitter enabled	Yes	CHANGE
RH set point	35 %	CHANGE
RH offset	0 %	CHANGE
+ PID tuning		
+ Dew pt transmitter	No	
+ Demand signal	No	
+ Humidistat	No	

+ LIMIT CONTROLS

- WATER TYPE

Potable enabled	Yes	CHANGE
Softened enabled	No	CHANGE
DI/RO enabled	No	CHANGE

+ WATER MANAGEMENT

+ FAN-BASED DISPERSION

+ REMOTE TEMP SENSOR

+ COMMUNICATIONS

+ PROGRAMMABLE OUTPUTS

+ SET DATE AND TIME

+ LANGUAGE

+ UNITS

+ SECURITY

+ CAPACITY ADJUST

+ RESET TO DEFAULTS

Callout boxes:

- Click on a tab label to move to another screen
- Click on CHANGE to change value
- To change value: Highlight value; type in new value; click on APPLY
- Click here to view alarms
- Click here to view messages
- Click on label to contract (-) or expand (+) menu item

© Copyright 2008 DRI-STEEM Corporation. All rights reserved.

Pre-installation Checklist

**Figure 8-1:
Vapor-logic4 control board detail**

Full board

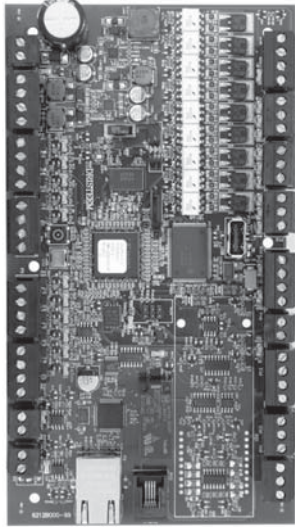

Terminals P-11 through P-16 have a white border on the Vapor-logic4 board. This is where you will make most of your field wiring connections.

Board detail showing white border

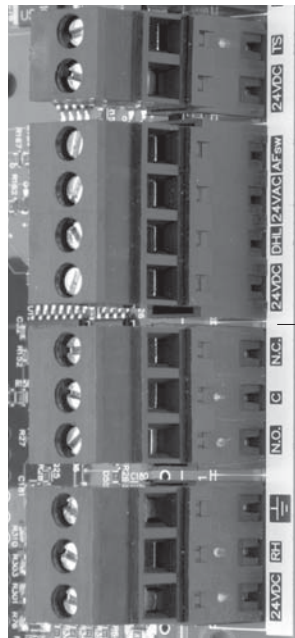

Field connection terminals have labels printed on a white border.

- See Figure 8-1 for field terminal block locations. Note that field wiring connection locations on the Vapor-logic4 board are surrounded with a white border.
- See the figure on the next page for instructions on how to make wiring connections.
- See the wiring drawings and manuals that shipped with your humidifier.
- When making field connections, do not route low voltage wires near line voltage wires. Do not route low voltage wires in the same conduit as line voltage wires.
- Humidistat, room/duct transmitter, temperature sensor, and airflow proving switch wiring must be minimum 18-gauge (1 mm²) plenum rated, shielded (screened), twisted pair wire with a bare drain wire for grounding.
- Connect the shield (screen) wire [with a length less than 2" (50 mm)] to the shield (screen) ground terminal on the electric subpanel. Do not ground the shield (screen) wire on the humidistat or transmitter end.
- If you have a remote-mounted control cabinet, the water level control device, thermal trip, safety interlock, fill valve, and drain valve wiring must be minimum 18-gauge (1 mm²) stranded wire run in a conduit separate from power wires.

Do not use shielded (screened) cable for water level control devices.

When the control cabinet is mounted remotely from the humidifier, connect a ground wire from the machine ground lug on the humidifier to the machine ground lug in the control cabinet. The bonding machine ground wire should be the same AWG (mm²) as the largest heater wire (electric humidifiers) or sized per local code, National Electrical Code (NEC), or in Europe, IEC 60364 requirements.

Pre-installation Checklist

Figure 9-1:
Vapor-logic4 terminal block detail and connection instructions

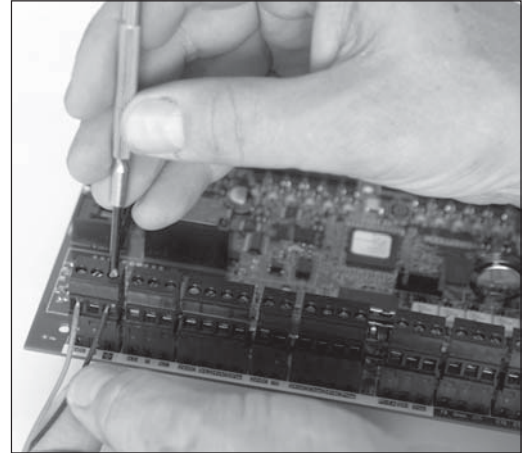
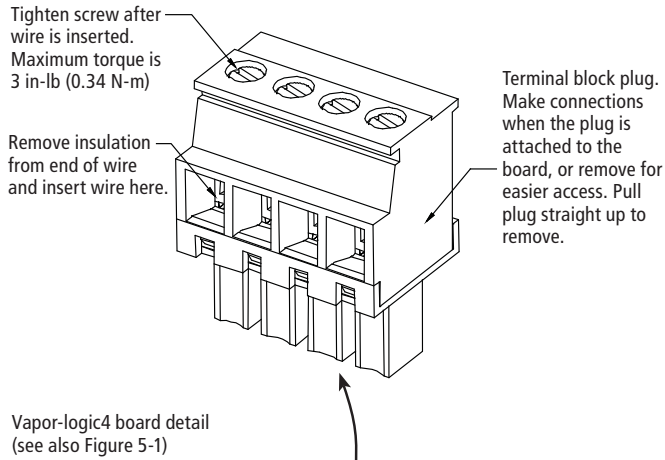

Vapor-logic4 board detail
 (see also Figure 5-1)

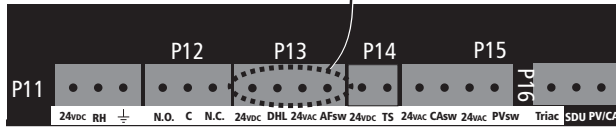

Installation process

The Vapor-logic4 board is designed to make installation very easy:

- Terminal blocks that require field connections are outlined in white.
- Terminal plugs can be removed to allow easy access when inserting wires and tightening screws.
- For most applications, humidifiers ship with the control board fully configured, with drain, fill, and other humidifier components factory-wired to the board, and the keypad/display attached to the humidifier and connected to the Vapor-logic4 board.

Installing Vapor-logic4 is a three-step process:

1. Connect field wiring from device to Vapor-logic4 board.

See instructions beginning on Page 12. Note that some connections listed here may not apply to your system.

- **Control input** (one required)
 - RH or dew point transmitter
 - Demand signal by others (4-20 mA or 0-10 VDC typical)
 - Room or duct humidistat
 - Demand signal by BACnet, Modbus, or LonTalk
- **Limit controls**
 - Airflow switch (duct or SDU)
 - Duct high limit on-off switch or transmitter
 - Temperature compensation transmitter (or auxiliary temperature sensor connected to same terminal)

Installation process

- **Communication connections**
 - Vapor-logic4 keypad
 - Ethernet
 - Modbus
 - BACnet
 - LonTalk
 - Multiple-tank communication
- **Programmable triac and relay**
- **Area-type, SDU dispersion fans, or steam blowers**
- **Combustion air switch and power vent (GTS systems only)**

2. Complete the Setup process.

See instructions beginning on Page 28.

3. Start up humidifier(s).

See instructions on Page 37.

Refer to the Pre-installation Checklist and drawings on the previous pages, and then make the field wiring connections as described on the following pages.

Step 1 – Field wiring: Control input

**Figure 12-1:
Terminal P11**

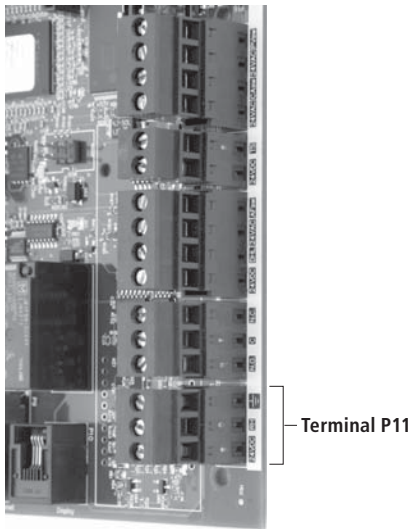

Terminal P11:

24VDC = Power to space RH sensor
 RH = Space RH input (RH transmitter, dew point transmitter, humidistat, or demand signal by others) (4-20 mA or 0-16 (typ. 0-10) VDC input
 ⚡ = Ground for demand signal by others

Note:

If you do not know which control components were ordered with your system, contact DRI-STEEM or connect your keypad/display to the Vapor-logic4 board per the instructions on Page 19. Go to the Setup menu per the instructions on Page 28 to view system parameters that were factory configured as ordered.

Connect control input signal wiring by inserting wires into Terminal P11 (labeled 24VDC, RH, and ground) per the wiring diagram on the next page. Tighten screws; maximum torque is 3 in-lb (0.34 N-m).

Allowed inputs at Terminal P11 include:

- **RH transmitter or dew point transmitter**
 Transmitters provide a signal proportional to the RH or dew point being measured. All transmitters provided by DRI-STEEM are two-wire devices using a 4 to 20 mA signal.
- **Demand signal by others**
 Demand signals are sent to the Vapor-logic4 board from another control system such as a building automation system. These systems have their own RH or dew point transmitters, calculate required humidifier output, and send a demand signal to the humidifier to create steam at a percentage of that humidifier’s capacity. Demand signals are typically 0-10 VDC or 4-20 mA, but may also come from a DDC signal via Modbus, BACnet, or LonTalk.

A **humidistat** also delivers a demand signal to the humidifier, but it is not typically used with Vapor-logic4.

Humidistats provide either on-off control or modulating control. DRI-STEEM humidistats are powered by a 24 VDC supply provided by the Vapor-logic4 control board.

When using modulating control, the signal from a humidistat directly controls the amount of output from the humidifier.

Notes:

- See Figure 13-1.
- For more information about control input signal types and operation, see “Control input signals” on Page 14.
- See “Modbus, BACnet, LonTalk interoperability” on Page 70 for more information about input signals.

Step 1 – Field wiring: Control input

Figure 13-1:
Vapor-logic4 control input wiring connections

Signal by others

0-10 VDC
SIGNAL BY OTHERS

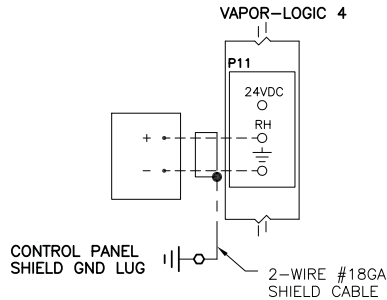

4-20 mA
SIGNAL BY OTHERS

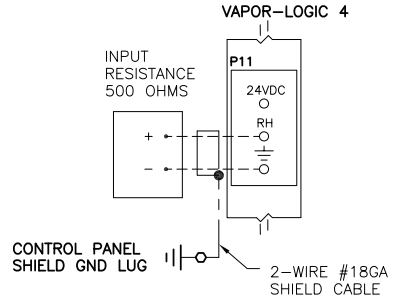

Transmitter

DEW POINT

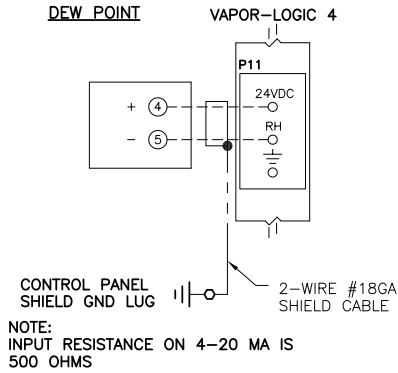

RH

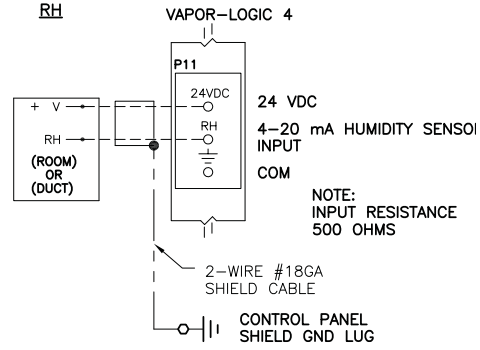

On-off RH humidistat

ROOM HUMIDISTAT

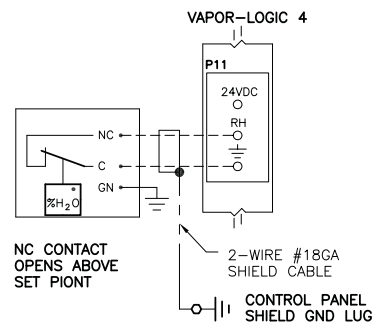

DUCT HUMIDISTAT

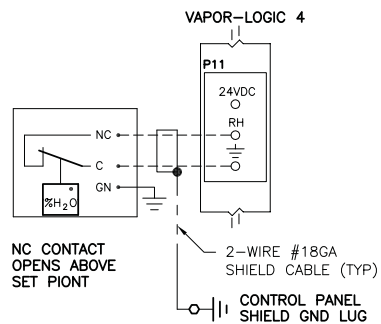

Key	CONTROL CIRCUIT WIRING	OPTIONAL FIELD
	Solid line	Dashed line
	Dotted line	Line with break symbol
	Line with break symbol	Line with break symbol
	Line with break symbol	Line with break symbol

Step 1 – Field wiring: Control input signals

DRI-STEEM offers three control options for all its humidification systems controlled by Vapor-logic4: On-off control, demand signal control, and transmitter control.

On-off control

On-off control—the simplest control scheme—does exactly what its name implies: the output device turns fully on, then fully off.

The humidistat that controls the humidifier has a differential between the on and off switch points. The differential is established at a range sufficient to prevent output short cycling. In other words, the humidity level has to fall below set point before the humidistat closes and energizes the humidifier. Once the humidifier is energized, the humidistat stays closed until the humidity is above set point. This creates an operating range that prevents the humidifier from running for very short periods of time.

In applications where there are multiple contactor outputs, such as an electric element humidifier, contactors for each heat stage are pulled in one at a time with a one-second delay between them. In applications with a variable output stage, such as a GTS humidifier, the outputs are ramped up until they reach 100%.

Step 1 – Field wiring: Control input signals

Modulating demand signal control

With modulating demand signal control, a modulating humidistat or a building automation system sends a signal to the Vapor-logic4 controller, which then sends a signal to the humidifier to produce a directly proportional steam output. For example, if a humidistat operating between 4 mA and 20 mA sends a 4 mA signal, the humidifier produces no output; a 12 mA signal causes the humidifier to run at 50% of capacity; and a 20 mA signal causes the humidifier to run at 100% capacity.

With a humidistat provided by DRI-STEEM producing this signal, the humidity set point is set at the humidistat. The keypad/display then is used for maintaining and troubleshooting the humidification system, with humidifier control stemming from the humidistat itself. With a building automation system (BAS) providing the signal, the humidity set point is established by the BAS, and the humidifier responds to the BAS commands.

Transmitter control

With transmitter control, the Vapor-logic4 board receives a signal that corresponds to the actual humidity level measured in the space being controlled. (With a transmitter provided by DRI-STEEM, the signal is 4 to 20 mA, which corresponds to 0 to 100% RH). The Vapor-logic4 controller employs an internal PID loop that uses this humidity measurement along with a user-defined humidity set point to calculate a demand level. This demand level is the level at which the humidifier will run. See “PID tuning” on Page 51.

Calculation of transmitter % RH

$$\% \text{ RH} = \frac{(\text{mA reading}) - 4 \text{ mA}}{16 \text{ mA}} \times 100\%$$

$$\text{Example: } \frac{12 \text{ mA} - 4 \text{ mA}}{0.16 \text{ mA}} \times 100\% = 50\% \text{ RH}$$

Step 1 – Field wiring: Limit controls

**Figure 16-1:
Terminal P13**

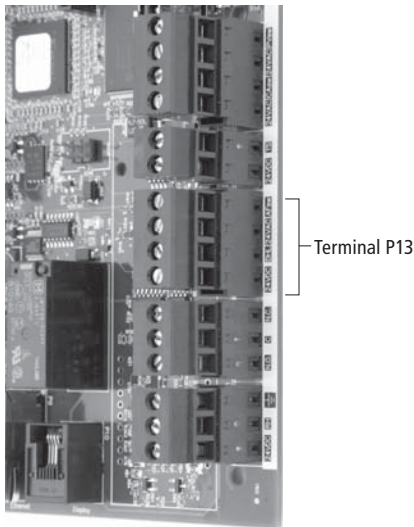

Terminal P13:
 24VDC = Power to duct high limit switch or transmitter
 DHL = Duct high limit switch/transm. (4-20 mA input)
 24VAC = Power to airflow proving switch
 AFsw = Airflow proving switch (24 VAC input)

Airflow proving switch

Connect wiring for a duct, Space Distribution Unit (SDU) airflow proving switch by inserting wires into the terminal block plug at P13 (labeled AFsw and 24VAC) per the wiring diagram on the next page. Tighten screws; maximum torque is 3 in-lb (0.34 N-m). (An SDU is a cabinet fan dispersion assembly.)

See also “Sensor placement” on Page 26.

Duct high limit switch or transmitter

Connect wiring for a duct high limit switch or transmitter by inserting wires into the terminal block plug at P13 (labeled DHL and 24VDC) per the wiring diagram on the previous page. Tighten screws; maximum torque is 3 in-lb (0.34 N-m).

Note: The duct high limit sensor connected at this location can be an on-off high limit switch, or it can be a duct high limit transmitter with an adjustable high limit set point (4-20 mA input).

See also “Sensor placement” on Page 26.

Step 1 – Field wiring: Limit controls

Figure 17-1:
Vapor-logic4 limit controls wiring connections

Airflow switch

In a duct

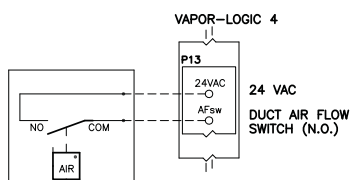

When using an SDU

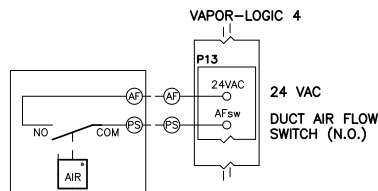

DUCT AIR FLOW SWITCH IS IN SDU CABINET
DUCT AIR FLOW SWITCH IS NOT USED ON AREA-TYPE

NOTE:
FIELD WIRING REQUIRED BETWEEN SDU CABINET TERMINAL STRIP AND CONTROL CABINET TERMINAL STRIP FOR SDU BLOWER AND AIR FLOW SWITCH.

Duct high limit (not used on SDU or Area-type)

ON/OFF

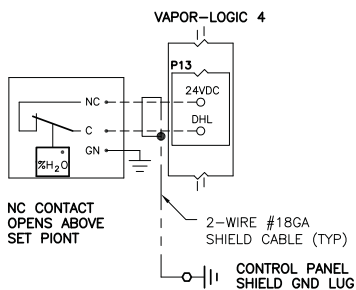

TRANSMITTER

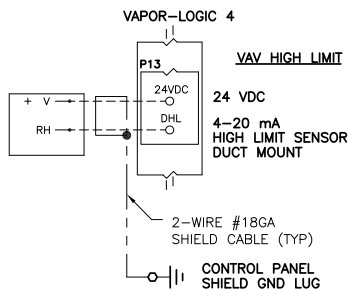

Temperature compensation transmitter or auxiliary temperature sensor

Note: This control is not available for XT humidifiers.

TEMP COMP TRANSMITTER

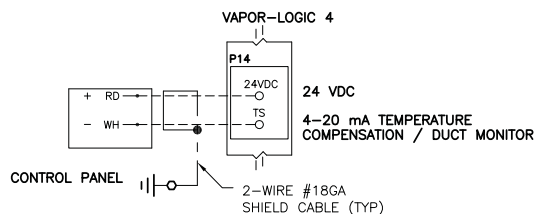

Key

CONTROL CIRCUIT WIRING
FIELD WIRING
OPTIONAL FACTORY

OPTIONAL FIELD
BREAK TO EXTERNAL CONNECTIONS DIAGRAM

Step 1 – Field wiring: Limit controls

**Figure 18-1:
Terminal P14**

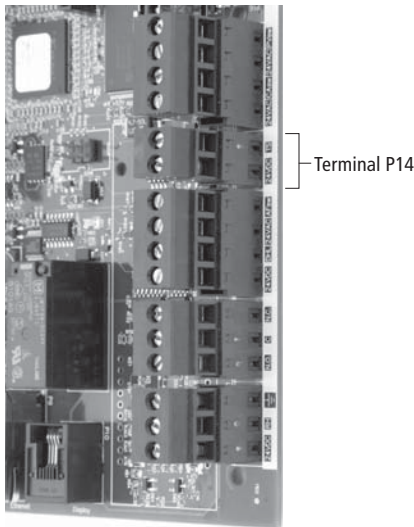

Terminal P14:
 24vdc = Power to auxiliary temperature sensor or temperature compensation sensor (transmitter)
 TS = Auxiliary temperature sensor or temperature compensation sensor (transmitter) (4-20 mA input)

Connect wiring for a temperature compensation transmitter or an auxiliary temperature sensor by inserting wires into the terminal block plug at P14 (labeled 24vdc and TS) per the wiring diagram on the previous page. Tighten screws; maximum torque is 3 in-lb (0.34 N-m).

Note: Only one device can be connected at P14. You will identify the connected device in “Step 2 – Setup,” beginning on Page 28.

Auxiliary temperature sensor

An auxiliary temperature sensor typically monitors duct or space air temperature. Mount the auxiliary temperature sensor wherever you want to monitor temperature. Auxiliary temperature readings are logged to the data log.

Temperature compensation transmitter

A temperature compensation transmitter allows Vapor-logic4 to reduce humidifier output on cold days, reducing window condensation. Mount the temperature compensation transmitter on the inside of an outside-wall window.

To mount the temperature compensation sensor:

1. See Figure 18-2. Position the temperature compensation sensor control box on a wall adjacent to a window frame facing north or northeast.
2. Place the flat surface of the temperature sensor tip on the lower corner of glass surface.
3. Temporarily hold the sensor tip in place with strips of masking tape.
4. Apply a small amount of clear RTV silicone adhesive over and around the sensor tip (making sure the sensor tip is in contact with the window glass).
5. After adhesive cures, remove masking tape.
6. See the operation section of this manual for more information about the temperature compensation sensor.

**Figure 18-2:
Temp. comp. transmitter installation**

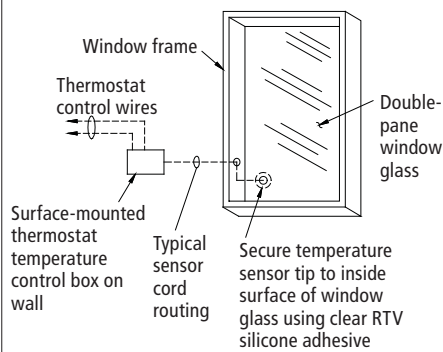

OM-337

Step 1 – Field wiring: Communication connections

Vapor-logic4 keypad/display

If your keypad/display is factory-mounted and connected to the Vapor-logic4 board, proceed to installing the next device required by your system.

If your keypad/display was shipped loose, mount the keypad/display in a location so that the provided cable is long enough to connect the keypad/display to the Vapor-logic4 board.

To connect a Vapor-logic4 keypad/display to the Vapor-logic4 board, insert the male end of the provided cable into the Vapor-logic4 board at Terminal P10 (labeled Display) until you hear a click sound (see also the wiring diagram on the next page). Plug the other end of the cable into the keypad/display. This connection provides DC power and communication to the keypad/display.

See Caution at right before routing cable.

If a longer keypad/display cable is needed, order a replacement cable from DRI-STEEM (see the replacement parts section of this manual), or use a four-conductor straight-through cable or a six-conductor, crossover, twisted pair cable connected to an RJ11 jack.

Note required operating conditions listed on Page 3.

Other than factory-mounted, there are three ways to mount the keypad/display. See Figure 19-2.

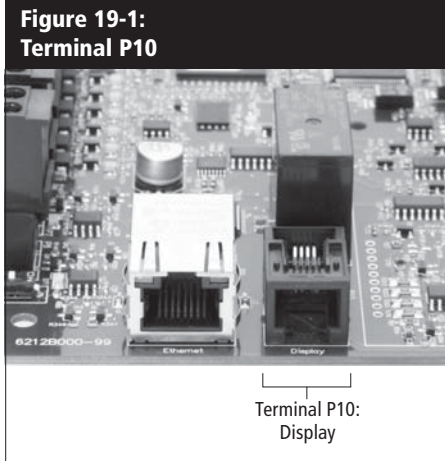

CAUTION

Keypad/display cable

Maximum cable length is 500' (152 m).

When routing keypad/display cable, route cable away from all power wiring.

**Figure 19-2:
Mounting the keypad/display**

Mount keypad/display back directly to wall



Mount keypad/display back to junction box



Mount keypad/display back to phone plate



Step 1 – Field wiring: Communication connections

Figure 20-1:
Vapor-logic4 communication wiring connections

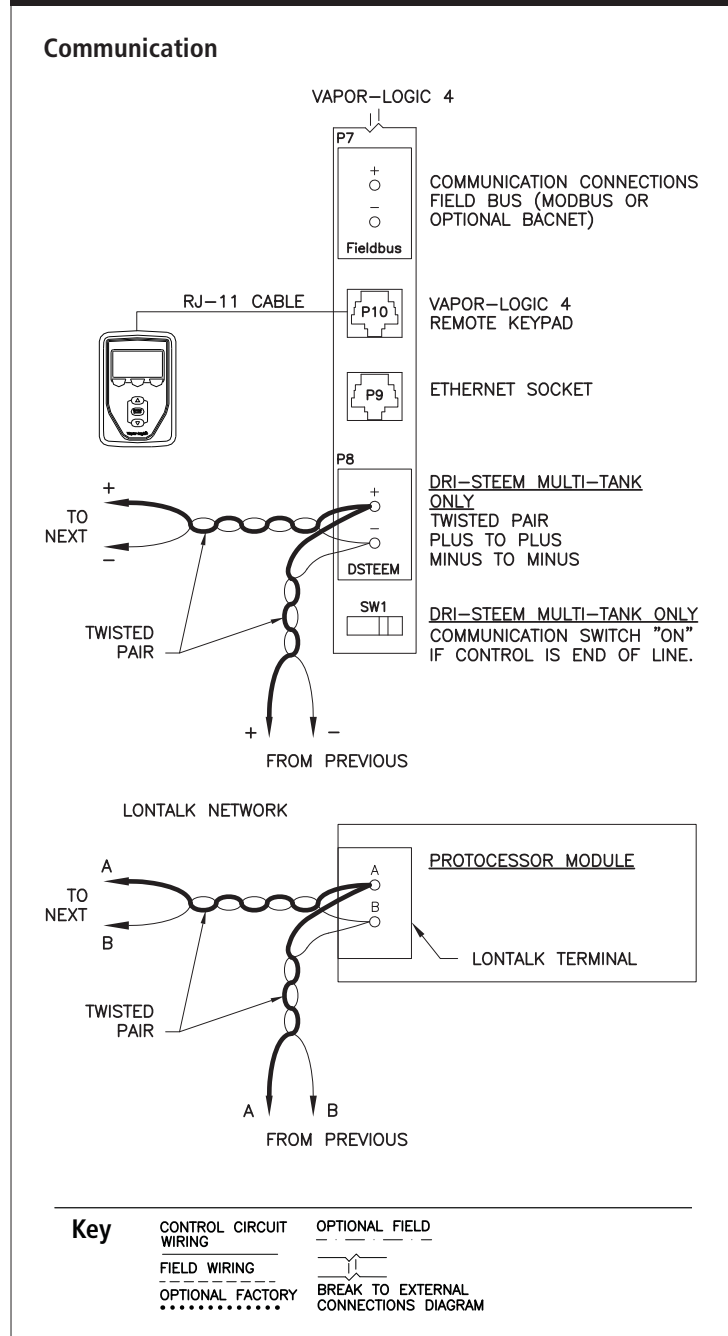

Step 1 – Field wiring: Communication connections

Web interface communication

Utilizing the Vapor-logic4 Web interface is optional. The humidifier can be operated using the keypad/display and/or the Web interface. When using the Web interface, the humidifier can be accessed by a computer either directly or through a network. Each Vapor-logic4 controller ships with the static IP address of **192.168.1.195**. This allows users to locate the Web interface upon start-up. After initial start-up, the IP address can remain as is, be re-assigned as another static address, or configured to automatically go out and find an IP address on the network using DHCP. See the steps below for information about connecting to the humidifier using the Web interface.

Connecting Web interface directly to a computer not on a network

1. Connect the Ethernet cable.

Insert the male end of an RJ45 Ethernet cable into the Vapor-logic4 board at P9 (labeled Ethernet; see Figure 21-1) until you hear a click sound. Insert the other end of the cable into a computer. Since the Ethernet port on the Vapor-logic4 board is auto-sensing, either a straight-through or crossover cable will work.

2. Check the current IP address of your computer.

Connecting a computer to the humidifier requires that the computer being used has the same network address range as Vapor-logic4. In order to validate this, check the IP address of the computer being used by going to the computer's Start menu and selecting Run. When the box shown below appears, type in **cmd** on the Open line and hit OK.

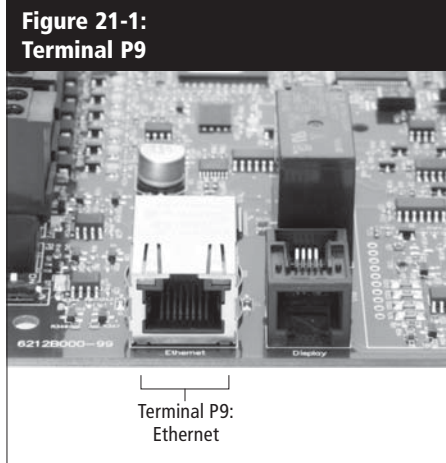

Vapor-logic4 default IP address

192.168.1.195.

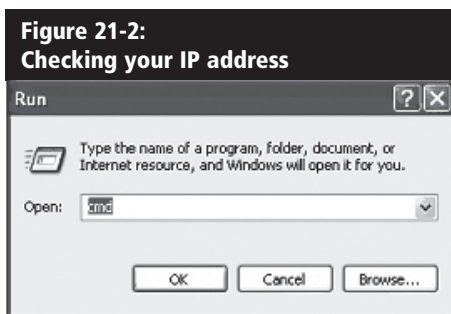

Step 1 – Field wiring: Communication connections

After a system prompt appears, type in **ipconfig** and then hit Enter. The current IP address of the computer should appear. If the first three segments of that IP address are different than the first three segments of the humidifier's default IP (192.168.1.xxx), you must change either your computer or Vapor-logic4's IP address such that they match each other.

**Figure 22-1:
Checking your IP address**

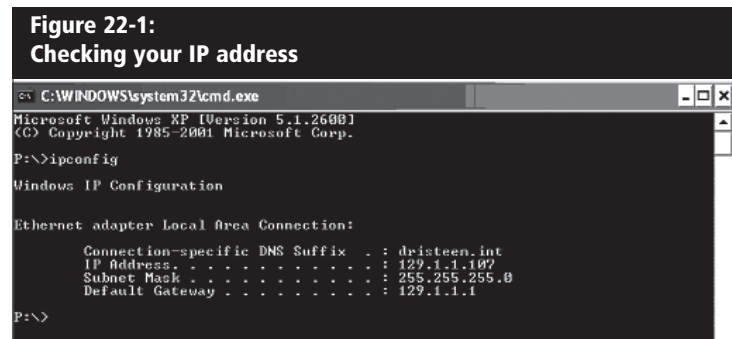

```
C:\WINDOWS\system32\cmd.exe
Microsoft Windows XP [Version 5.1.2600]
(C) Copyright 1985-2001 Microsoft Corp.

P:\>ipconfig

Windows IP Configuration

Ethernet adapter Local Area Connection:

    Connection-specific DNS Suffix  . : dristeen.int
    IP Address. . . . .               : 129.1.1.107
    Subnet Mask . . . . .             : 255.255.255.0
    Default Gateway . . . . .         : 129.1.1.1

P:\>
```

3. **Change the IP address of your humidifier or computer if necessary.**
 - a. **Change the IP address of the humidifier to work with your computer.**

The most straightforward way to change the IP address of the humidifier using Vapor-logic4 is to use the keypad/display. Go to Setup/Communications/Network IP address on the keypad/display and change the IP address such that the first three segments of the computer's settings match the network address. Make sure the last digit of the IP address is different between the humidifier and the computer. Cycle power of Vapor-logic4 board for address change to take effect.
 - b. **Change the IP address of your computer to match the humidifier.**

Changing the IP address of the computer being used will likely require administrative privileges for your company's network. Please consult your IT department for this task.

Step 1 – Field wiring: Communication connections

4. Connect to the humidifier.

- a. Using a computer connected to the Vapor-logic4 board, open a Web browser such as Mozilla® Firefox® or Internet Explorer®.
- b. Find the browser address bar (see Figure 23-1), delete all existing text in the browser address bar, type the Vapor-logic4 IP address into the browser's address bar, and press Enter.

Note: The Vapor-logic4 default IP address is **192.168.1.195**

Connecting Web interface to an Ethernet network

See Caution at right before proceeding.

If your network uses DHCP (Dynamic Host Configuration Protocol), use the keypad/display to navigate to: Setup/Communications/Network IP Address. Enable DHCP and restart the Vapor-logic4 board.

The most current IP address can always be found by using the keypad/display to navigate to: Set-Up/Communications/Network IP Address.

Important: DHCP cannot be enabled from the Web interface; it must be enabled using the keypad/display.

Other communication connections

For BACnet or LonTalk installation instructions, see Page 70.

For multiple-tank installation instructions, see Page 77.

**Figure 23-1:
Entering the IP address**



CAUTION

Vapor-logic4 IP address

Before you connect a Vapor-logic4 device to a network, please contact your IT department. Given that the Vapor-logic4 controller ships with a static IP address, it is important to ensure that there is not another device with that same IP address already on the network. Working with your IT department before network connection will help ensure the integrity of the network and the devices on that network.

DHCP and IP address

When DHCP is enabled, the server can dynamically change the IP address of Vapor-logic4, making existing bookmarks unusable.

Step 1 – Field wiring:

**Figure 24-1:
Terminal P16**

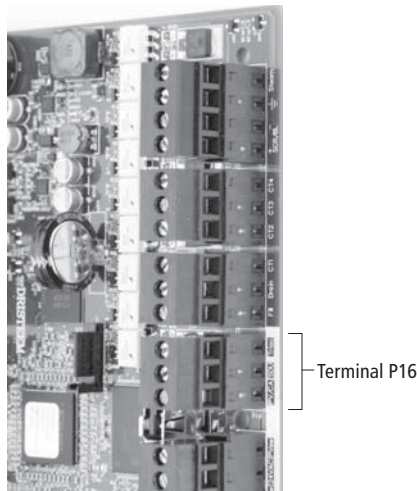

Terminal P16: (all are triacs)
 Triac = Programmable output (4 AMP max.)
 (Note: Connect ground at P19)
 PV/CA = Power vent/combustion air control signal
 (24 VAC output)
 SDU = Space Distribution Unit (24 VAC output)

**Figure 24-2:
Terminal P12**

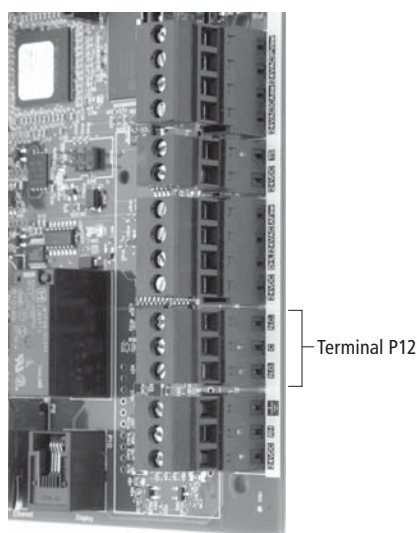

Terminal P12:
 Programmable relay (dry contact) (10 AMP max. rated)
 N.O. = Normally open
 C = Common
 N.C. = Normally closed

Programmable triac

See “Programmable triac maximum current” in Caution below.

Connect wiring to the output by inserting wires into the terminal block plug at P16 (labeled Triac) and into the terminal block plug at P19 (labeled ground), per the wiring diagram in Figure 25-1. This connection allows remote activation of a device such as a fan or signal light. Output parameters are defined during Step 2 of the installation process.

Programmable relay (dry contact)

See “Programmable relay maximum current” in Caution below.

See Figure 25-1. Connect wiring for remote signaling using a programmable relay (dry contact) by inserting wires into the terminal block plug at P12 (labeled N.O., C, and N.C.), per the wiring diagram in Figure 25-1. Tighten screws; maximum torque is 3 in-lb (0.34 N-m).

This connection allows remote activation of a device such as a fan or signal light. Output parameters are defined during Step 2 of the installation process.

CAUTION

Programmable triac maximum current

Programmable triac (P16) is rated for 100 mA from the factory, and up to 4 Amps when a 24 VAC, 4 Amp (100 VA) transformer is wired in parallel to the factory transformer. Exceeding this maximum rating can cause the triac component or the Vapor-logic4 board to fail.

Programmable relay maximum current

Programmable relay (dry contact) (P12) is rated for 24 VAC, 10 Amp maximum. Exceeding this maximum rating can cause the relay component or the Vapor-logic4 board to fail.

Step 1 – Field wiring:

Figure 25-1:
Vapor-logic4 programmable triac and relay wiring connections

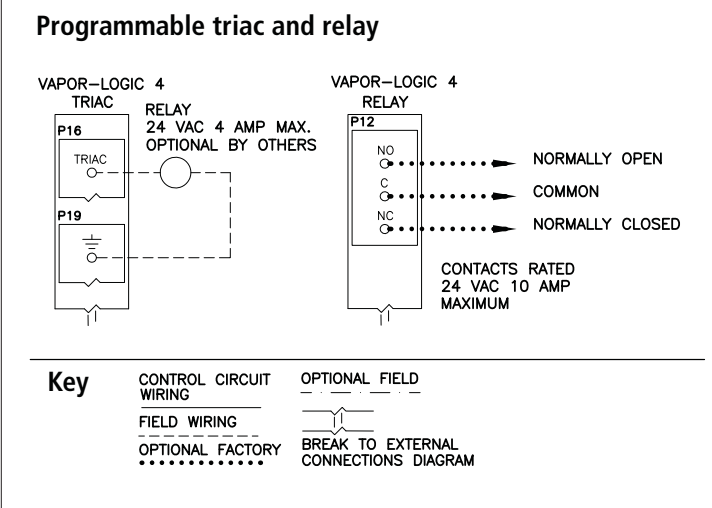

Area-type and SDU dispersion fans

Connect wiring for Area-type and Space Distribution Unit (SDU) dispersion fans by inserting the wire into the terminal block plug at P16 (labeled SDU). Tighten screws; maximum torque is 3 in-lb (0.34 N-m).

Optional combustion air switch and power vent (GTS systems)

Connect wiring for GTS combustion air switch and/or GTS power vent by inserting wires into the terminal block plugs at P15 and P16. Tighten screws; maximum torque is 3 in-lb (0.34 N-m).

The combustion air switch is on the combustion air damper. The power vent switch indicates airflow at the power venter.

Figure 25-2:
Terminal P16

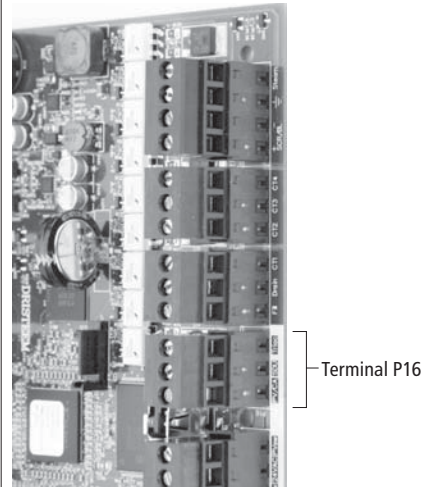

Terminal P16: (all are triacs)
 Triac = Programmable output
 (Note: Connect ground at P19)
 PV/CA = Power vent/combustion air control signal
 (24 vac output)
 SDU = Space Distribution Unit (24 vac output)

Figure 25-3:
Terminal P15

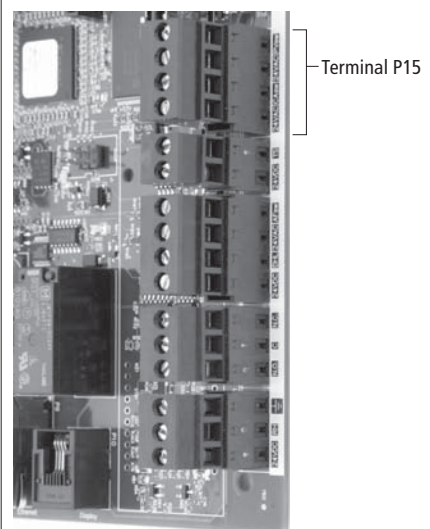

Terminal P15:
 24vac = Power to combustion air switch
 CASw = Combust. air sw. (24vac input)
 24vac = Power to power vent switch
 PVsw = Power vent switch (24vac input)

Step 1 – Field wiring: Sensor placement

Other factors affecting humidity control

Humidity control involves more than the controller's ability to control the system. Other factors that play an important role in overall system control are:

- Size of humidification system relative to load
- Overall system dynamics associated with moisture migration time lags
- Accuracy of humidistats and humidity transmitters and their location
- Dry bulb temperature accuracy in space or duct
- Velocities and airflow patterns in ducts and space environments
- Electrical noise or interference

mc_060508_0750

Humidistat and sensor locations are critical

Humidistat and sensor location have a significant impact on humidifier performance. In most cases, do not interchange duct and room humidity devices. Room humidity devices are calibrated with zero or little airflow; whereas duct humidity devices require air passing across them.

Recommended sensor locations (see figure below):

- A** Ideal. Ensures the best uniform mix of dry and moist air with stable temperature control.
- B** Acceptable, but room environment may affect controllability, such as when sensor is too close to air grilles, registers, or heat radiation from room lighting.
- C** Acceptable. Provides uniform mixture of dry and moist air. If extended time lag exists between moisture generation and sensing, extend sampling time.
- D** Acceptable (behind wall or partition) for sampling entire room if sensor is near an air exhaust return outlet. Typical placement for sampling a critical area.
- E** Not acceptable. These locations may not represent actual overall conditions in the space.
- F** Not acceptable. Do not place sensors near windows, door passageways, or areas of stagnant airflow.
- G** Best sensing location for a high-limit humidistat or humidity transmitter and airflow proving switch.

Step 1 – Field wiring: Sensor placement

**Figure 27-1:
Recommended sensor location**

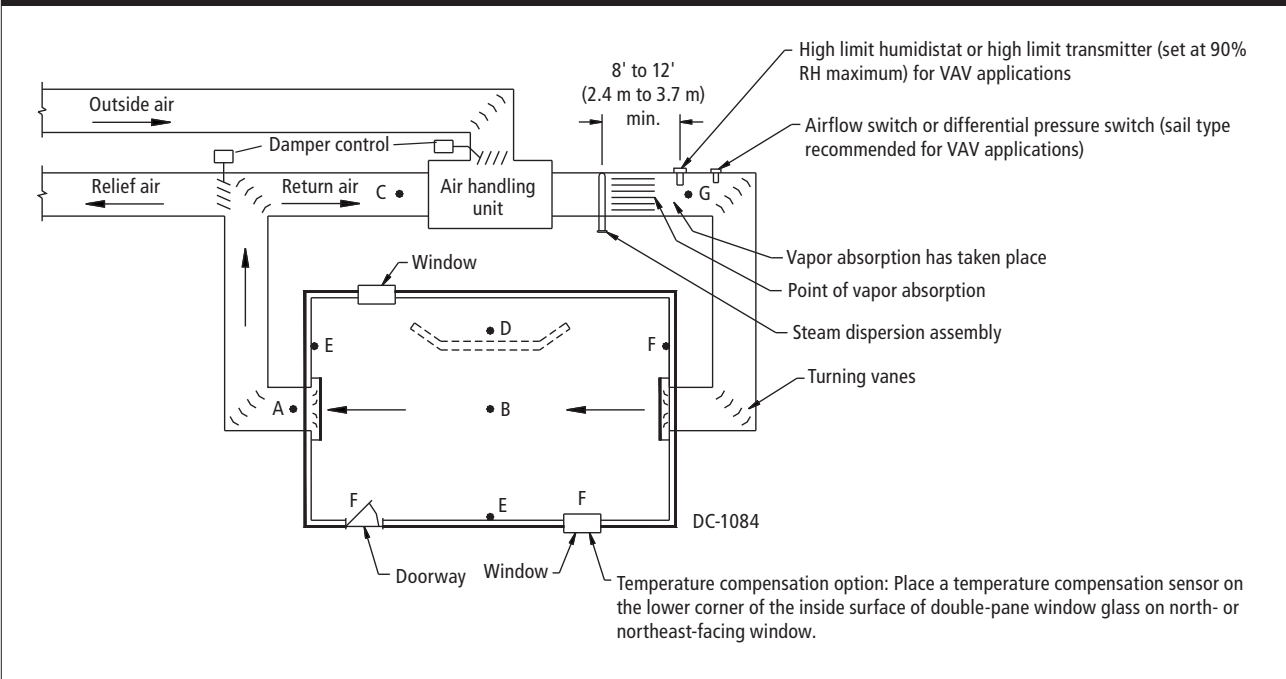

Step 2 – Setup

Figure 28-1: Keypad/display screens

"A" indicates that these settings apply to Tank A. All humidifier tanks are labeled as "A" except in applications where multiple humidifiers are controlled by one controller.

"1/15" indicates the highlighted item is the first of fifteen items

Push Up or Down arrow to scroll through menu items; press Enter to select highlighted item

```

SETUP          1/15  A
-----
InPut signal
Limit controls
Water type
Water management
Fan-based dispersion
MAIN  HOME  BACK
-----
INPUT SIGNAL  1/4  A
-----
RH transmitter
Dew Pt transmitter
Demand signal
Humidistat
MAIN  HOME  BACK
-----
RH X-MITTER  2/4  A
-----
Transmitter enabled
On
RH set Pt
35%
MAIN  HOME  BACK
    
```

To simplify the field-installation process, humidifiers are sent from the factory configured as ordered. However, some settings are unknown at the factory and need to be defined during the setup process using the Setup menu. The Setup menu is also where you make future system setting changes.

To begin the field setup process, go to the Setup menu on either the keypad/display or the Web interface. Setup menu parameters are listed in Table 30-1. Options and defaults are the same whether viewed from the keypad/display or Web interface. However, labels may be abbreviated on the keypad/display.

Using the keypad/display

To access the Setup menu on the keypad/display, press the Main softkey on the Vapor-logic4 keypad (see figure below). Press the Down arrow on the keypad until Setup is highlighted. Press Enter.

After entering the Setup menu, press the Up and Down arrows to scroll through all setup parameters or to change values. Use the Enter key to select parameters.

Figure 28-2: Using the Vapor-logic4 keypad

Typical Home screen

Press Main softkey to go to Main menu; press Up or Down arrow to move through menus and screens

Press Up or Down arrow to move through menus and screens

Press Enter to select or confirm

Step 2 – Setup

Using the Web interface

Although not required for humidifier operation, the Web interface allows convenient and remote access to Vapor-logic4.

See Page 21 for Web interface connection and IP address instructions. Follow the instructions below to complete the setup process.

Setup screen

Figure 29-1:
Using the Vapor-logic4 Web interface (Setup screen shown)

The screenshot shows the Vapor-logic4 web interface. At the top, there is a navigation bar with tabs for STATUS, ALARMS, DIAGNOSTICS, **SETUP**, and HELP. The DRISTEEM logo is on the left, and 'Vapor-logic4' is on the right. A callout box points to the 'SETUP' tab with the text 'Click on a tab label to move to another screen'.

The main content area is divided into several sections:

- System Status:** A table showing SPACE RH (58%), SET POINT (35%), and OUTPUT (0%).
- RUN MODE:** Local standby
- TANK STATUS:** Warm
- Alarms:** 0 active alarms, with a link to View Alarms. A callout box points to this link with the text 'Click here to view alarms'.
- Messages:** 1 active message, with a link to View Messages. A callout box points to this link with the text 'Click here to view messages'.
- SETUP:** The main configuration area. It includes:
 - INPUT SIGNAL:**
 - RH transmitter:**
 - Transmitter enabled: Yes (with a CHANGE button)
 - RH set point: 35 % (highlighted, with a CHANGE button and a callout box 'Click on CHANGE to change value')
 - RH offset: 0 % (with a CHANGE button)
 - + PID tuning
 - + Dew pt transmitter: No
 - + Demand signal: No
 - + Humidistat: No
 - LIMIT CONTROLS**
 - WATER TYPE:**
 - Potable enabled: Yes (with a CHANGE button)
 - Softened enabled: No (with a CHANGE button)
 - DI/RO enabled: No (with a CHANGE button)
 - + WATER MANAGEMENT**
 - + FAN-BASED DISPERSION**
 - + REMOTE TEMP SENSOR**
 - + COMMUNICATIONS**
 - + PROGRAMMABLE OUTPUTS**
 - + SET DATE AND TIME**
 - + LANGUAGE**
 - + UNITS**
 - + SECURITY**
 - + CAPACITY ADJUST**
 - + RESET TO DEFAULTS**

Additional callouts include: 'Click on label to contract (-) or expand (+) menu item' pointing to the expand/collapse icons, and 'To change value: Highlight value; type in new value; click on APPLY' pointing to the highlighted '35 %' value.

At the bottom of the page, there is a copyright notice: © Copyright 2008 DRI-STEEM Corporation. All rights reserved.

Step 2 – Setup

Table 30-1: Setup menu						
Menu item	Default value	Minimum value	Maximum value	Units	Notes	
Note: Your system might not have all of the items listed in this table (Pages 30 through 36).						
Input signal						
RH transmitter						
Transmitter enabled	--	No	Yes	--		
RH set point	35	0	100	%	DRI-STEEM recommends using default values for offsets and PID settings when first setting up your humidifier.	
RH offset	0	-20	20	%		
PID tuning	--	--	--	--		
RH PID band	10	0	50	%		
Proportional gain	80	0	1000	---		
Integral gain	40	0	1000	---		
Derivative gain	0	0	1000	---		
Dew pt transmitter						
Transmitter enabled	--	No	Yes	--		
Dew point set point	50	20	80	°F	DRI-STEEM recommends using default values for offsets and PID settings when first setting up your humidifier.	
	10	-6	26	°C		
Dew point offset	0	-20	20	°F		
	0	-11	11	°C		
Dew point minimum	0	-100	Maximum	°F / °C		
Dew point maximum	100	Minimum	100	°F / °C		
PID tuning	--	--	--	--		
Dew point PID band	10	1	20	°F		
	5	1	20	°C		
Proportional gain	80	0	1000	--		
Integral gain	40	0	1000	--		
Derivative gain	0	0	1000	--		
Demand signal						
VDC signal	--	--	--	--		
VDC signal enabled	--	No	Yes	--		
0% output at	1.0	0.0	Maximum	VDC		
100% output at	9.0	Minimum	10.0	VDC		
mA signal						
mA signal enabled	--	No	Yes	--		
0% output at	4.0	0.0	Maximum	mA		
100% output at	20.0	Minimum	20.0	mA		
Control via Modbus						
Modbus controlled	No	No	Yes	--	Choose Modbus, BACnet, or LonTalk in this section only if your demand input signal is via Modbus, BACnet, or LonTalk. If you are interoperating (sharing operating parameters with a building automation system) using Modbus, BACnet, or LonTalk protocols, see also the Communications Setup options.	
Control via BACnet						
BACnet controlled	No	No	Yes	--		
Control via LonTalk						
LonTalk controlled	No	No	Yes	--		

Continued

Step 2 – Setup

Table 30-1: Setup menu (continued)					
Menu item	Default value	Minimum value	Maximum value	Units	Notes
Humidistat	--	--	--	--	
Humidistat enabled	No	No	Yes	--	
Limit control					
HL switch	--	--	--	--	
Switch in system	Yes	No	Yes	--	
HL transmitter	--	--	--	--	
Transmitter enabled	No	No	Yes	--	
Duct HL set point	80	5	95	% RH	
Duct HL span	5	0	20	% RH	Span (throttle span) is an offset below the high limit set point where the humidifier reduces output but does not turn off until the device high limit set point is reached.
Duct HL offset	0	-20	20	% RH	
Water type (not an XT menu item)					
Potable enabled	--	No	Yes	--	 WARNING Water type setting Changing the water type setting from potable/softened to DI/RO, or from DI/RO to potable/softened requires humidifier hardware changes. Changing the water type setting without the required hardware changes can cause component failure, severe property damage, severe personal injury, or death.
Softened enabled	--	No	Yes	--	
DI/RO enabled	--	No	Yes	--	

Continued

Step 2 – Setup

Table 30-1: Setup menu (continued)					
Menu item	Default value	Minimum value	Maximum value	Units	Notes
Water management					
Drain valve (not an XT menu item)	--	--	--	--	Changing drain valve settings requires changing the drain valve.
Type	Model-specific	Damper	Motorized	--	
Actuator	Electric	Manual	Electric	--	
Status	Normally closed (N.C.)	Normally closed (N.C.)	Normally open (N.O.)	--	
Auto drain/flush (not an XT menu item)	--	--	--	--	Auto drain/flush requires a humidifier with an electric drain valve.
Drain/flush enabled	--	No	Yes	--	When enabled, the humidifier automatically drains and then flushes the tank at user-defined intervals.
Usage	Model-specific	0	2,200,000	lbs	Select amount of water to be converted to steam before auto drain/flush starts.
		0	1,000,000	kg	
Schedule enabled	--	--	--	--	Select days of week auto drain/flush is allowed once usage requirement is met.
Allowed days	--	--	--	--	
Sunday	Yes	No	Yes	--	
Monday	Yes	No	Yes	--	
Tuesday	Yes	No	Yes	--	
Wednesday	Yes	No	Yes	--	
Thursday	Yes	No	Yes	--	
Friday	Yes	No	Yes	--	
Saturday	Yes	No	Yes	--	
Time to drain/flush	0	0	23	--	Select time of day (24 hour clock) auto drain/flush starts once usage requirement is met.
Drain duration	Model-specific	0	120	Minutes	Select number of minutes for drain valve to remain open during auto drain/flush. Default value is based on tank and valve size.
Flush duration	Model-specific	0	15	Minutes	Select number of minutes for fill valve to remain open during flushing.

Continued

Step 2 – Setup

Table 30-1: Setup menu (continued)					
Menu item	Default value	Minimum value	Maximum value	Units	Notes
Water management (continued)					
Skim (not an XT menu item)	--	--	--	--	
Skim enabled	Yes	No	Yes	--	Enabled as default except on DI water systems.
Skim duration	Model-specific	0	120	Seconds	
End-of-season drain					
EOS enabled	Yes	No	Yes	--	Enabled as default except on DI water systems. If enabled, the humidifier tank drains after the humidifier has been idle for a user-defined time.
Idle time for EOS	72	1	168	Hours	Select number of hours humidifier is idle before end-of-season draining starts.
Aquastat (not an XT menu item)	--	--	--	--	The minimum aquastat setting prevents tank water freezing. Higher settings keep tank water warm, reducing time required to bring water to boiling after a call for humidity.
Aquastat enabled	--	No	Yes	--	
Aquastat set point	50 10	40 4	180 82	°F °C	
Service interval					
Service interval	Model-specific	0	2,200,000	lbs	Select amount of water to be converted to steam or hours that humidifier runs before service interval is reached.
	Model-specific	0	1,000,000	kg	
	Model-specific	0	10,000	Hours	
Probe threshold					
Probe threshold	800	300	2000	--	
Probe debounce time	2	1	10	Seconds	Amount of time the water probe must be in or out of water to change the water/no water state.
Fill fault time	40	40	250	Minutes	Amount of fill time before an alarm will occur.
XT management (XT only)					
Tempering enabled	Model-specific	No	Yes	--	Enables drain tempering for XT. Tempering turns on the fill valve whenever the drain is energized and may not be required if the drain line can accommodate boiling water.
TP Mode enabled	Model-specific	No	Yes	--	TP Mode allows the humidifier to more closely track demand by cycling the contactor when current is greater than the demand signal requirement.
Turn on percent	20	10	20	%	Minimum run level when TP mode is disabled.
Fan-based dispersion					
Changing fan-based dispersion settings can require component changes for system to operate correctly.					
SDU	--	--	--	--	An SDU is a space distribution unit, which disperses steam using a fan housed in a cabinet.
SDU on system	--	No	Yes	--	
Area-type	--	--	--	--	An Area-type dispersion unit is a caged fan mounted on top of the humidifier tank.
Area-type on system	--	No	Yes	--	
Time delay	--	--	--	--	Select number of minutes fan-based dispersion unit operates after water in tank stops boiling. A delay keeps the fan running until all steam is dispersed.
Output time delay	5	1	30	Minutes	

Continued

Step 2 – Setup

**Table 30-1:
Setup menu (continued)**

Menu item	Default value	Minimum value	Maximum value	Units	Notes
Remote temp sensor (not an XT menu item)					Changing temperature sensor settings can require component changes for system to operate correctly.
Temp compensation	--	--	--	--	
Temp comp enabled	--	No	Yes	--	
Temp monitor	--	--	--	--	
Temp monitor enabled	--	No	Yes	--	
Temp sensor offset	--	--	--	--	Used to calibrate temperature monitoring sensor and temperature compensation sensor
Temp sensor offset	0	-20	20	°F	
	0	-11	11	°C	
Communications					Changing communications settings can require component changes for system to operate correctly.
BACnet	--	--	--	--	
Unlock code	0	0	999999	--	
BACnet enabled	--	No	Yes	--	
BACnet comm channel	19200MS/TP	BACnet IP	76800 MS/TP	--	
Device instance	255	0	4194303	--	
MS/TP station	1	0	127	--	MS/TP only
Max masters	127	0	127	--	MS/TP only
UDP port (47808)	47808	1024	65535	--	BACnet/IP only
Modbus	--	--	--	--	
Modbus enabled	--	No	Yes	--	
Modbus baud rate	9600	4800	38400	--	
Modbus address	99	0	255	--	
LonTalk	--	--	--	--	
LonTalk enabled	--	No	Yes	--	
Network IP address	--	--	--	--	
Network IP address	192.168.1.195	0.0.0.0	255.255.255.255	--	
Network IP mask	255.255.255.0	0.0.0.0	255.255.255.255		
Enable DHCP	No	No	Yes	--	Use keypad/display to access this menu item. This item is not available when using the Web interface.

Continued

Step 2 – Setup

Table 30-1: Setup menu (continued)					
Menu item	Default value	Minimum value	Maximum value	Units	Notes
Programmable outputs					
Dry contact	--	--	--	--	CAUTION Programmable dry contact maximum current Programmable dry contact (P12) is rated for 24 VAC, 10 Amp maximum. Exceeding this maximum rating can cause the dry contact (relay) component or the Vapor-logic4 board to fail.
All alarms	Yes	No	Yes	--	A dry contact activates whenever there is an alarm.
Selected alarms/messages	No	No	Yes	--	A dry contact activates whenever there are alarms or messages selected from the setup list.
Heat on-off enabled	No	No	Yes	--	A dry contact activates when the humidifier is heating.
Steam yes-no enabled (not an XT menu item)	No	No	Yes	--	A dry contact activates when the tank temperature reaches boiling.
24 VAC triac	--	--	--	--	CAUTION Programmable triac maximum current Programmable triac (P16) is rated for 100 mA from the factory, and up to 4 Amps when a 24 VAC, 4 Amp (100 VA) transformer is wired in parallel to the factory transformer. Exceeding this maximum rating can cause the triac component or the Vapor-logic4 board to fail.
All alarms	No	No	Yes	--	A triac activates whenever there is an alarm.
Selected alarms/messages	No	No	Yes	--	A triac activates whenever there are alarms or messages selected from the setup list.
Heat on-off enabled	No	No	Yes	--	A triac activates when the humidifier is heating.
Steam yes-no enabled (not an XT menu item)	No	No	Yes	--	A triac activates when the tank temperature reaches boiling.
Set date and time					
Date	--	1/1/2007	1/1/2099	mm/dd/yy	
Time	--	0:00	23:59	Hours:Minutes	24 hour clock
Language					
Display in English	--	No	Yes	--	Select one language for both keypad/display and Web interface communications.
Display in French	--	No	Yes	--	
Display in German	--	No	Yes	--	
Display in Spanish	--	No	Yes	--	

Continued

Step 2 – Setup

Table 30-1: Setup menu (continued)					
Menu item	Default value	Minimum value	Maximum value	Units	Notes
Units					
Display inch-pound	--	No	Yes	--	
Display SI	--	No	Yes	--	
Security					
Require password	No	No	Yes	--	
Set password	None	0	9999	--	Enter a four-digit password using numbers only.
Time-out	5	1	120	Minutes	The number of inactivity minutes Vapor-logic4 remains in read-write mode before returning to read-only mode
Capacity adjust					
Capacity calibration (GTS systems)	100.0	0.0	245.0	%	Changing the capacity calibration setting changes reported, not actual, humidifier output.
Capacity calibration (XT systems)	100.0	10.0	100.0	%	Changing the capacity setting changes the actual humidifier output.
Idle time					
Idle time	5	1	120	Minutes	Select number of minutes keypad/display remains idle before returning to the Home screen.
Reset to defaults					
Reset to defaults	--	--	--	--	CAUTION This action cannot be reversed Select this if you want to reset all humidifier settings to factory defaults
Valve span					
Span	Min 2.00 Max 10.00	0.00	10.00	VDC	

Step 3 – Startup

To start up your humidifier, go to the Start-up Checklist in your humidifier’s Installation, Operation, and Maintenance manual.

Staging multiple XT humidifiers

Up to four XT electrode steam humidifiers can be staged to operate in sequence. In a sequenced application, one control input signal is divided by user-selectable settings among the humidifiers connected in sequence. See the Vapor-logic4 board connection points in Figure 37-1.

Control input examples

Table 37-1: Control input example for four XT humidifiers in sequence		
XT humidifier	Control input	Result
H-1 (primary)	Any valid Vapor-logic4 control input	0 to 100% steam output corresponding to 4–20 mA or 0–10 VDC control signal
H-2 (staged)	4–6 VDC*	0 to 100% steam output scaled across 4–6 VDC range
H-3 (staged)	6–8 VDC*	0 to 100% steam output scaled across 6–8 VDC range
H-4 (staged)	8–10 VDC*	0 to 100% steam output scaled across 8–10 VDC range

* User-selectable, 0–10 VDC in 0.1V increments.

Table 37-2: Control input example for two XT humidifiers in sequence		
XT humidifier	Control input	Result
H-1 (primary)	Any valid Vapor-logic4 control input	0 to 100% steam output corresponding to 4–20 mA or 0 to 10 VDC control signal
H-2 (staged)	5–10 VDC*	0 to 100% steam output scaled across 5–10 VDC range

* User-selectable, 0–10 VDC in 0.1V increments.

Setting control input ranges

- Using the keypad/display or Web interface, go to the Tank setup menu, then select Input signal, then Demand signal.
- Select Yes to enable user input.
- Scroll down to select the range for each staged input.
- Press the Enter key to confirm selections.

Multi-tank mode

XT humidifiers do not operate in multi-tank mode. See “Multiple-tank operation” on Page 77.

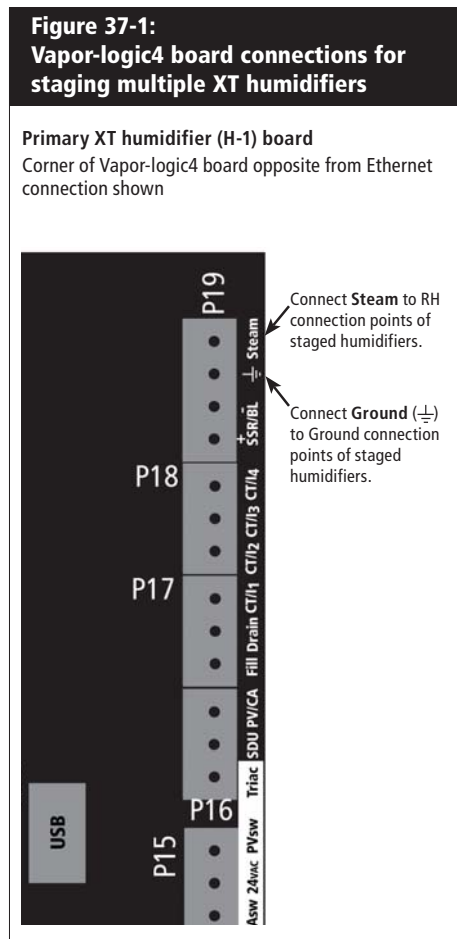

Contact DRI-STEEM if you need assistance staging XT humidifiers. See “Calling DRI-STEEM Technical Support” on Page 84.

Using menus and screens

Figure 38-1:
Using the keypad/display

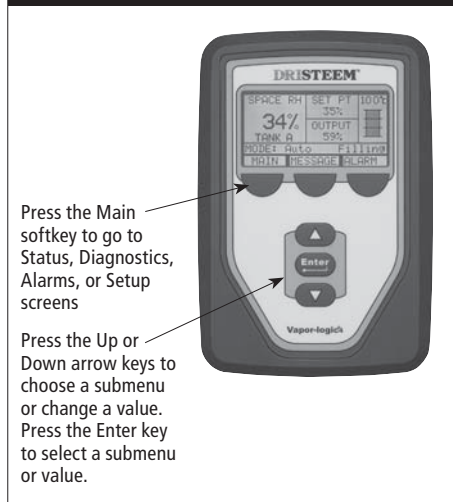

Vapor-logic4 keypad/display has the following menus and screens:

- Home screen
- Main menu, and four submenus:
 - Status
 - Diagnostics
 - Alarms
 - Setup

Press the Main softkey to go to the Main menu selection screen. Press the Up and Down arrow keys to choose a submenu and press Enter to select.

Vapor-logic4 Web interface has the following screens:

- Status
- Diagnostics
- Alarms
- Setup
- Help

Click on tab labels to go to other screens. The highlighted tab indicates the current screen.

Figure 38-2:
Using the Vapor-logic4 Web interface (Status screen shown)

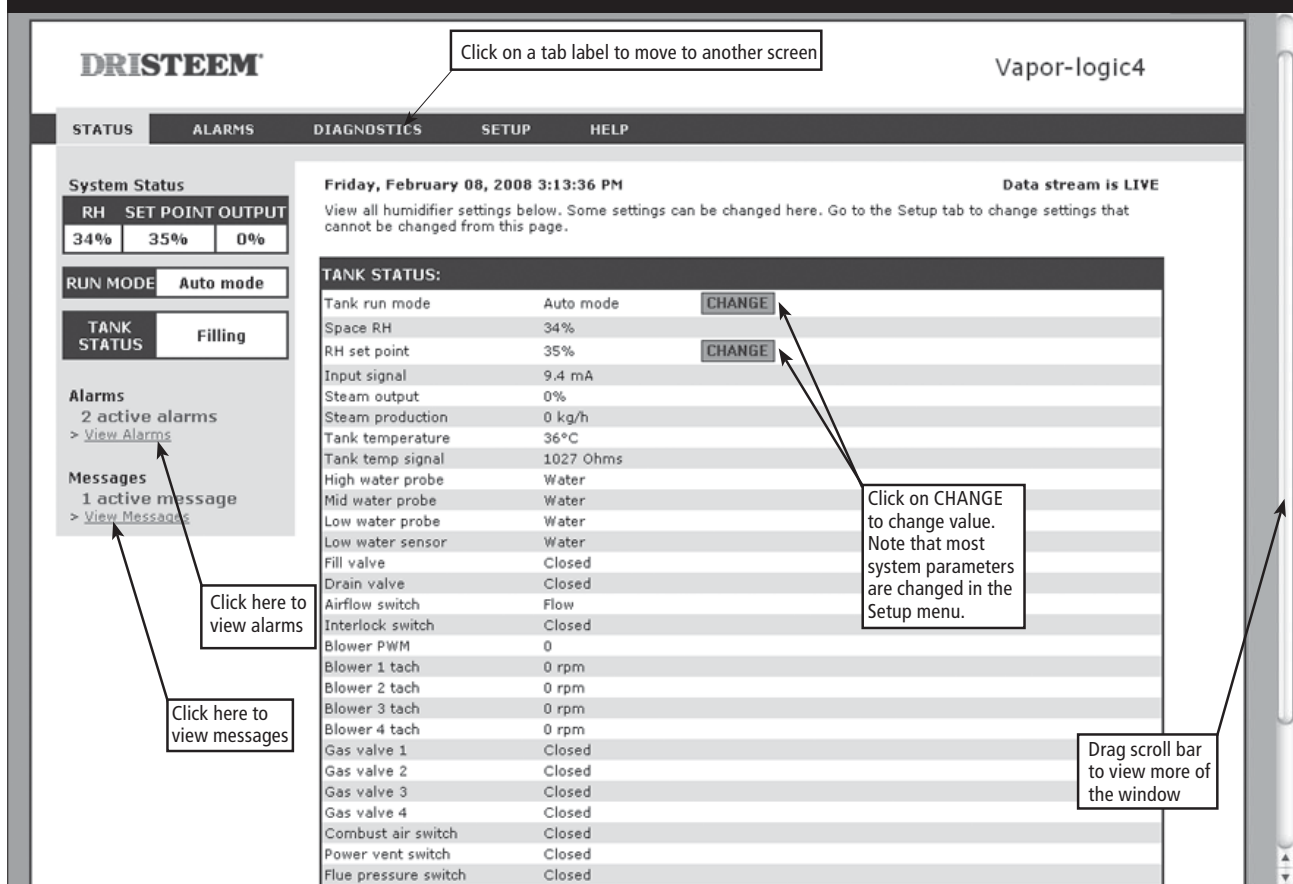

Home screen (keypad/display)

Vapor-logic4 returns to the Home screen on the keypad/display after a user-defined period of idleness. The Home screen displays the items most frequently viewed: Actual space RH or dew point, RH or dew point set point, tank/system output or steam demand, humidifier mode, and tank activities such as filling, skimming, heating, boiling, and draining.

There is a tank level indicator on the right side of the screen. See the table below for a description of tank level indicators.

Above the tank level indicator is a tank temperature display showing actual tank temperature.

Changing mode and set point

Mode and Set point can be changed from the Home screen. Press the Up or Down arrow key until the Set point or Mode is highlighted, press Enter, press Up or Down arrow key to change value, press Enter to confirm. All other parameters shown on the Home screen are for viewing only and cannot be changed. Go to the Setup menu to change these items.

Tank activities defined

- **Filling:** Fill valve remains open until water reaches operating level.
- **Skimming:** Fill valve is open to allow water to flow through the overflow port, skimming off precipitated minerals (tap and softened water systems only).
- **Draining:** Tank is draining.
- **Flushing:** Fill and drain valve are open to flush tank (tap and softened water systems only).
- **Heating:** Water in tank is heating.
- **Boiling:** Water in tank is boiling and there is a demand for humidity.
- **Hot:** Water is at boiling temperature and there is no demand for humidity.
- **Warm:** Water temperature is equal to or greater than 100 °F (38 °C) and not boiling.
- **Cold:** Water temperature is less than 100 °F (38 °C).
- **EOS drain:** Humidifier is in end-of-season drain.
- **Empty:** There is no water in the humidifier and there is no demand for humidity.
- **Idle:** No demand or an active alarm preventing operation (XT only).
- **TmpDrain:** Humidifier is doing a drain to reduce conductivity or eliminate foam. Process can take several minutes for large-capacity humidifiers. (XT only).
- **Full:** Water level has reached top of cylinder (XT only).

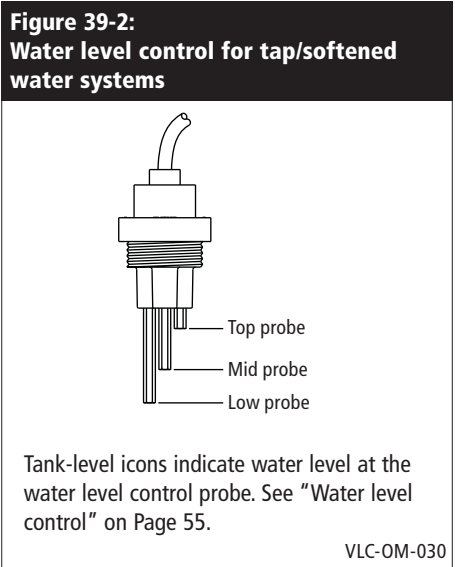
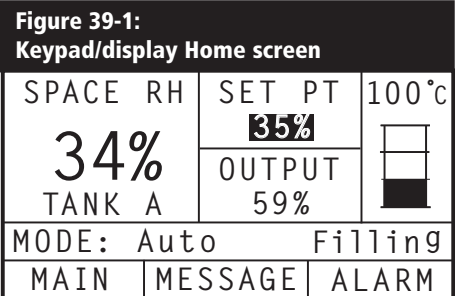





Table 39-1:
Fill icon

	Indicates in:	
	Tap/softened water systems (see Figure 39-2)	DI/RO water systems
	Water level is above top probe.	Water is above low water level.
	Water level is between mid and top probes.	N/A
	Water level is between low and mid probes.	N/A
	Water level is below low probe (heat is disabled).	Water is below low water level (heat is disabled).

Note: XT humidifier display does not include fill icon (see Figure 57-1).

Status screen

Figure 40-1: Keypad/display screens

"A" indicates these settings apply to Tank A. All humidifier tanks are labeled as "A" except in applications where multiple humidifiers are controlled by one controller.

"1/4" indicates the highlighted item is the first of four items

Push Up or Down arrow to scroll through menu items; press Enter to select highlighted item

MAIN MENU 1/4 A

Tank status
Diagnostics
Alarms
Tank setup

HOME

TANK STATUS 2/24 A

Mode
Auto

Space RH
34% RH

MAIN HOME BACK

TANK STATUS 3/24 A

Space RH
34% RH

RH set Point
35% RH

MAIN HOME BACK

Using either the keypad/display or the Web interface, the Status screen is where all humidifier parameters can be viewed.

See the tables on the following pages for Status screen item descriptions for both the keypad/display and Web interface.

Figure 40-2: Web interface Status screen

DRISTEEM Vapor-logic4

STATUS ALARMS DIAGNOSTICS SETUP HELP

System Status
RH SET POINT OUTPUT
34% 35% 0%

Friday, February 08, 2008 3:13:36 PM Data stream is LIVE
View all humidifier settings below. Some settings can be changed here. Go to the Setup tab to change settings that cannot be changed from this page.

RUN MODE: Auto mode CHANGE

TANK STATUS: Filling

Alarms: 2 active alarms View Alarms

Messages: 1 active message View Messages

TANK STATUS:

Tank run mode	Auto mode	CHANGE
Space RH	34%	
RH set point	35%	CHANGE
Input signal	9.4 mA	
Steam output	0%	
Steam production	0 kg/h	
Tank temperature	36°C	
Tank temp signal	1027 Ohms	
High water probe	Water	
Mid water probe	Water	
Low water probe	Water	
Low water sensor	Water	
Fill valve	Closed	
Drain valve	Closed	
Airflow switch	Flow	
Interlock switch	Closed	
Blower FWH	0	
Blower 1 tach	0 rpm	
Blower 2 tach	0 rpm	
Blower 3 tach	0 rpm	
Blower 4 tach	0 rpm	
Gas valve 1	Closed	
Gas valve 2	Closed	
Gas valve 3	Closed	
Gas valve 4	Closed	
Combust air switch	Closed	
Power vent switch	Closed	
Flue pressure switch	Closed	

Drag scroll bar to view more of the window

Status screen

**Table 41-1:
Status screen**

Note: Your system might not have all of the items listed in this table (Pages 41 and 42).

Menu item	Default value	Minimum value	Maximum value	Units	Notes
Tank run mode	Standby	--	--	--	<p>Operating mode of humidifier. Choose from Auto, Standby, or Drain.</p> <ul style="list-style-type: none"> In Auto mode, the humidifier operates normally. All humidifier components are monitored and controlled. If there is a call for humidification, the system reacts. In Standby mode, the humidifier is offline. All humidity control inputs appear but are not acted upon; however, if the tank temperature falls below the freeze protect set point, the drain valve opens. In Drain mode, the automatic drain valve (if so equipped) opens and the tank drains. All humidifier operation is suspended, and the drain valve remains open until the unit is taken out of Drain tank mode. <p>See the Diagnostics section for information about Test outputs and Test run modes.</p>
Space RH	--	0	100	%	
RH set point	35	0	100	%	
Input signal	--	0	10	VDC	
	--	0	20	mA	
Dew point	--	0	100	°F	
	--	-17	37	°C	
Dew point set point	50	20	80	°F	
	10	-6	26	°C	
Steam demand	--	0	100	%	Displays steam demand as a percent of capacity
Steam output	--	0	100,000	lbs/hr	
	--	0	100,000	kg/h	
Duct RH	--	0	100	%	
Duct HL switch	--	Open	Closed	--	
Duct HL set point	80	0	100	%	
Duct HL signal	--	0	20	mA	
Tank temperature	--	15	265	°F	
	--	-9	129	°C	
Tank temp signal	--	0	2200	Ohms	
Aux temperature	--	-20	160	°F	
	--	-29	71	°C	
Aux temp signal	--	4	20	mA	

Continued

Status screen

**Table 41-1:
Status screen (continued)**

Menu item	Default value	Minimum value	Maximum value	Units	Notes
High probe signal*	--	0	4000	counts	Systems using tap or softened water control water levels electronically using a three-rod probe. The controller initiates the following events when the probes are in contact with water: High probe: Fill valve closes Mid probe: Fill valve opens Low probe: Low water cut-off The display indicates the probe is in contact with water by indicating "Water" or "No water."
High water probe*	--	No water	Water	--	
Mid probe signal*	--	0	4000	counts	
Mid water probe*	--	No water	Water	--	
Low probe signal*	--	0	4000	counts	
Low water probe*	--	No water	Water	--	The high, mid, and low probe signal counts, displayed on the Status screen, indicate: <800 = Probe is properly reading water 800-1200 = Faulty water probe (causes a "Faulty water probe" alarm) 1200-1600 = Probe requires maintenance (causes a "Clean probes" message) >1600 = Probe is dry
DI low water switch*	--	No water	Water	--	
Airflow switch	--	Flow	No flow	--	
Interlock switch	--	Open	Closed	--	
Water until drain/flush*	--	0	2,200,000	lbs	Displays amount of water to be converted to steam before automatic drain sequence (ADS) can begin
	--	0	1,000,000	kg	
Water until service	--	0	2,200,000	lbs	Displays amount of water to be converted to steam before next recommended maintenance service
	--	0	1,000,000	kg	
Hours until service	--	0	10,000	hours	XT systems only
Lifetime hours	--	0	100,000	hours	XT systems only
Blower 1 tach	--	0	7000	rpm	Displays rotation speed of Blower 1 (GTS systems only)
Blower 2 tach	--	0	7000	rpm	Displays rotation speed of Blower 2 (GTS systems only)
Blower 3 tach	--	0	7000	rpm	Displays rotation speed of Blower 3 (GTS systems only)
Blower 4 tach	--	0	7000	rpm	Displays rotation speed of Blower 4 (GTS systems only)
Gas valve 1	--	Open	Closed	--	GTS systems only
Gas valve 2	--	Open	Closed	--	GTS systems only
Gas valve 3	--	Open	Closed	--	GTS systems only
Gas valve 4	--	Open	Closed	--	GTS systems only
Combust air switch	--	Flow	No Flow	--	GTS systems only
Power vent switch	--	Open	Closed	--	GTS systems only
Flue pressure switch	--	Open	Closed	--	GTS systems only
Low water sensor	--	No water	Water	--	GTS systems only
Current	--	0	Model dependent	Amps	XT systems only
High water probe	--	No water	Water	--	XT systems only
Current 2	--	0	Model dependent	--	Right cylinder of 2-cylinder model, XT systems only
High water probe 2	--	No water	Water	Amps	Right cylinder of 2-cylinder model, XT systems only

* Not an XT menu item

Diagnostics screen

The Diagnostics screen provides access to system messages, system data, humidifier information, and test functions.

See the following pages for more information about the Diagnostics screen.

System messages and the Messages Log

When a system event occurs (e.g., when regularly scheduled unit servicing becomes due), a system message is added to the Messages Log (“Service unit”). The Messages Log displays the message name, date and time of occurrence, plus whether the message is active, has been cleared by an operator, or auto-cleared by Vapor-logic4. Active messages display first in the Messages Log, followed by cleared messages, listed in order of occurrence. The Messages Log displays up to ten messages. As new messages enter the log, the oldest, cleared messages leave the log first.

Messages auto-cleared by Vapor-logic4 describe events that have resolved on their own. For example, a “No airflow” message appears when there is no airflow in the duct. If airflow returns, the “No airflow” message auto-clears, but stays in the Messages Log (per the rules described above) to let the operator know there was an airflow interruption.

The keypad/display highlights the Message softkey label when there is a system message. When this occurs, press the Message softkey to view the Messages Log.

The Web interface displays a link to system messages in the upper left corner of the screen. Click on the link to view system messages (see the next page).

See Pages 64 through 69 for more information about downloading data, USB backup and restore, and test modes.

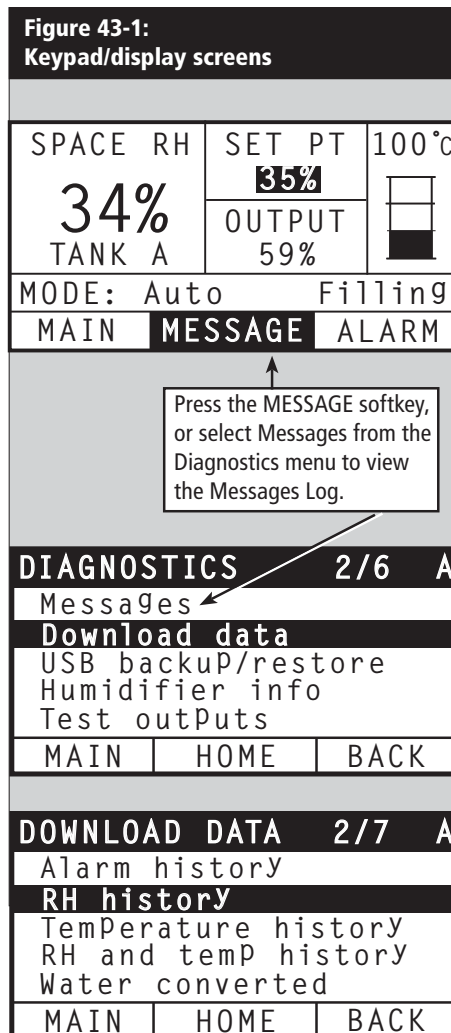

Diagnostics screen

Figure 44-1:
Vapor-logic4 Web interface Diagnostics screen

DRISTEEM Vapor-logic4

STATUS ALARMS **DIAGNOSTICS** SETUP HELP

System Status
 RH: 34% SET POINT: 35% OUTPUT: 0%

RUN MODE Auto mode

TANK STATUS Filling

Alarms
 2 active alarms
[View Alarms](#)

Messages
 1 active message
[View Messages](#)

Fri Feb 8 15:13:36 2008 Data stream is STOPPED [START LIVE DATA](#)

View system data and humidifier information, or test humidifier operation on this page.

DIAGNOSTICS

+ DOWNLOAD DATA

- USB BACKUP/RESTORE

Backup settings

Restore settings

+ HUMIDIFIER INFO

+ TEST RUN

- TEST OUTPUTS

Fill valve

Drain valve

Fan control

Programmable triac

Dry contact relay

Spare analog output

Ignition module 1

Ignition module 2

Ignition module 3

Ignition module 4

Blower speed control

Power vent control

MESSAGES

Message Details	Status	Action
Drain pending 2008-01-16 11:47:58 Auto drain/flush will occur at next scheduled time.	Active	<input type="button" value="CLEAR"/>
Duct HL trip 2008-01-16 11:47:59 Duct relative humidity has risen above set point, or high limit switch has opened.	Auto Cleared	

View messages by clicking on "View Messages" on any screen or by opening the Diagnostics screen.

Click on buttons to activate functions.

Clear messages by clicking here.

Diagnostics screen

Table 45-1: Diagnostics menu			
Menu item	Minimum value	Maximum value	Notes
Note: Your system might not have all of the items listed in this table (Pages 45 through 47).			
Download data			
Download to USB	--	--	Download all data sets to the USB flash drive.
Download via Ethernet	--	--	Only available from web page
Data point interval	30 seconds	900 seconds	Interval that data will be stored
USB backup/restore			
Back up settings	No	Yes	Humidifier settings can be backed up to or restored from a USB flash drive.
Restore settings	No	Yes	
Humidifier info			
Factory string	--	--	Displays as-shipped configuration string
Current string	--	--	Displays current configuration string
Serial number	--	--	Displays humidifier serial number
Firmware version	--	--	Displays current firmware version of Vapor-logic4 control board
Firmware date	--	--	Displays current firmware date of Vapor-logic4 control board
Model	--	--	XT systems only
Voltage	--	--	XT systems only
Phase	--	--	XT systems only
Test outputs			
Fill valve	--	--	Cycles output to verify operation.
Drain valve	--	--	
Fan control	--	--	
Programmable triac	--	--	
Dry contact relay	--	--	

Continued

Diagnostics screen

**Table 45-1:
Diagnostics menu (continued)**

Menu item	Default value	Minimum value	Maximum value	Units	Description
Test outputs (continued)					
Contactors 1, 2, 3, or 4	--	--	--	--	Cycles output to verify operation.
SSR control	--	--	--	--	
Ignition module 1, 2, 3, or 4	--	--	--	--	
Blower speed control	--	--	--	--	
Power vent control	--	--	--	--	
Steam valve	--	--	--	--	
Test run*					
Test run percent	0	0	100	%	Set demand percent value between 0 and 100 to test.
Test run time	0	0	30	minutes	Set test run time duration between 0 and 30 minutes.
Start					
Stop					
* Humidifier test run will not occur if safety circuits (for example, duct high limit switch, airflow proving switch, or safety interlock switch) are not operating correctly.					

Continued

Diagnostics screen

Table 45-1: Diagnostics menu (continued)		
Message	Description	Does message auto-clear?
Messages		
Replace contactors	Contactors have reached normal life span. Replace contactors.	No
Service unit	Regularly scheduled unit servicing is due.	No
Drain pending	Auto drain/flush will occur at next scheduled time.	Yes
No airflow	No duct airflow	Yes
l-lock open	Interlock safety switch is open.	Yes
Freeze drain	Tank has drained to prevent freezing.	Yes
EOS active	The humidifier is draining or has drained and remains inactive until receiving another call for humidity.	Yes
Temp comp on	Humidifier output has been reduced because temperature compensation sensor reads a temperature on the inside-pane of an outside-wall window that could cause condensation.	Yes
Clean probes	Water level control probes need cleaning. Check tank for cleaning.	No
Duct HL trip	Duct relative humidity has risen above the high limit set point, or high limit switch has opened.	Yes
Duct HL span	Duct high limit humidistat has entered the throttle span range and is approaching duct high limit set point.	Yes
Insufficient water	The low water probe is not in contact with water when there is a demand for humidity.	Yes
Boiling temp calibrated	Indicates actual humidifier boiling temperature at time of reading. This reading is taken after power-up by the tank sensor at the time of first steam creation.	Yes
Check cylinder / high water (XT systems only)	Clean water, or end of cylinder life. After 10 hours of normalized 100% run time, target current has not been reached, water is at the high water probe, and current has not increased from the previous reading. Humidifier continues to operate.	Yes, if target current is reached
	Clean supply water (cleaner than cylinder water). Filling has stopped due to reaching the high water probe, and the current has decreased three times in a row. Humidifier continues to operate.	
Notes: <ul style="list-style-type: none"> • The Messages Log displays message name, date and time of occurrence, plus "Active," "Cleared" or "Auto-cleared." • Active messages display first in the Messages Log, followed by cleared messages (auto-cleared and/or manually-cleared) listed in order of occurrence. • The Messages Log displays a maximum of 10 messages. Cleared messages leave the log first. • If a message event occurs and is not manually or auto cleared during unit operation, the message will stay there until there is demand and the unit is running. 		

Alarms screen

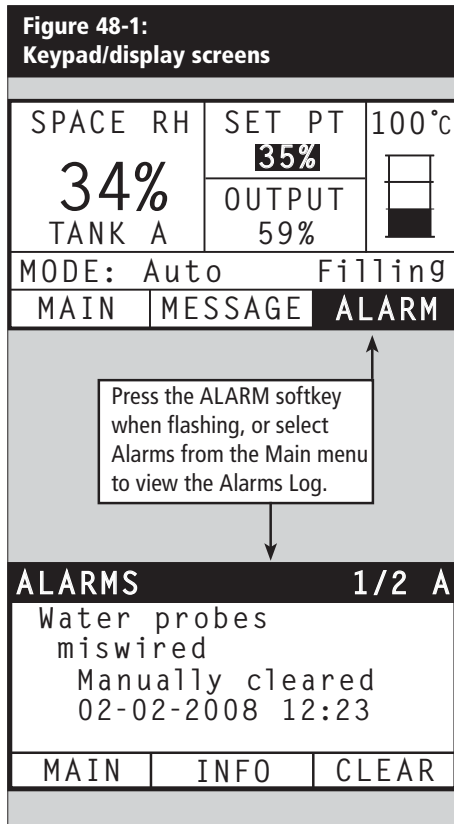

The Alarms menu displays system alarms. Using the keypad/display, go to the Alarms menu by pressing the Alarms softkey (which will be flashing if there is an Alarm), or by pressing the Home softkey and then the Alarms softkey. Using the Web interface, click on the View Alarms link in the upper left corner of any screen.

System alarms are listed in the Alarms Log. The Alarms Log displays the alarm name, date and time of occurrence, plus whether the alarm is active, has been cleared by an operator, or auto-cleared by Vapor-logic4. The Alarms Log lists active alarms at the top of the list, followed by cleared alarms. The Alarms Log holds 30 alarms. As alarms are cleared, they move down the list below active alarms. When the Alarms list reaches 30 alarms, new alarms add to the top of the list and the oldest, cleared alarms leave the list. Alarm information is retained in nonvolatile memory if the Vapor-logic4 board loses power.

See Table 49-1 for alarms and their descriptions

Alarm causes and recommended actions are listed in the troubleshooting section in this manual.

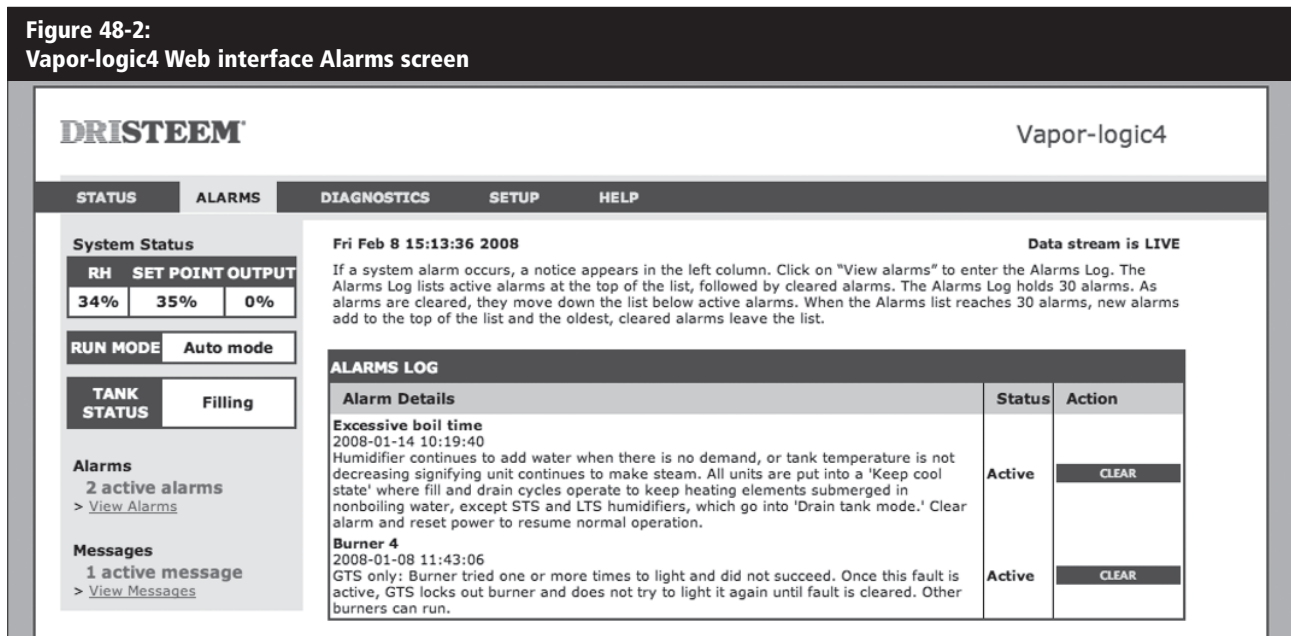

Alarms screen

Table 49-1: Alarms menu		
Alarm label	Description	Does alarm auto-clear?
Tank temp sensor failed	Tank temp sensor has failed.	No
RH signal out of range	RH signal is out of range.	Yes
Dew point sig. out of range	Dew point signal is out of range.	Yes
Demand signal	Demand signal is out of range.	Yes
Duct RH signal out of range	Duct RH signal is out of range. Sensor may be faulty.	Yes
Aux temp sens out of range	Auxiliary temp sensor signal is out of range.	Yes
Water probe miswired	Water probe head is miswired or faulty.	Yes
Faulty water probe	Water probe readings are suspect, likely caused by scale on probe.	No
Excess fill time	Fill valve has been on too long during initial tank fill. Bottom probe is not in contact with water.	Yes
Excess refill time	Re-filling is taking too long. Top probe is not in contact with water.	Yes
Tank not draining	Drain valve has been open for the prescribed amount of time based on the humidifier model, and water is still touching the low water probe.	Yes
Tank overtemp	Fault occurs at boiling temperature plus 25 °F (13 °C). All units are put into a keep-cool state where fill and drain cycles operate to keep tank cool. First resolve any safety issues, then resolve whatever is causing the problem. Restart the controller, and clear the alarm.	No
Excessive boil time	Humidifier continues to add water when there is no demand, signifying humidifier is continuing to make steam. Humidifier is put into a keep-cool state where fill and drain cycles operate to keep tank water from boiling. First resolve any safety issues, then resolve whatever is causing the problem. Restart the controller, and clear the alarm. Note: This alarm applies only to non-DI/RO-water humidifiers and DI/RO-water humidifiers with EOS drain.	No
No SDU airflow	Airflow proving switch in the SDU (space distribution unit, a fan-based dispersion assembly) indicates no airflow. No steam is produced while alarm is active.	Yes
No power vent airflow	Pressure switch indicates there is no airflow at the power venter.	Yes
No combustion airflow	Switch indicates the combustion air damper is closed.	Yes
Blocked flue (GTS systems only)	Flue pressure switch indicates positive pressure in flue. Burner will not ignite when this fault is active.	Yes
Burner 1, 2, 3, or 4 fault	Burner tried one or more times to light and did not succeed. Once this fault is active, Vapor-logic4 locks out the burner and does not try to light it again until fault is cleared. Other burners can run.	No
Ignition mod. 1, 2, 3, or 4 fault	Ignition module has not opened the gas valve. Once this fault is active, Vapor-logic4 locks out the ignition module and does not try to start it again until fault is cleared. Other ignition modules can run.	No
Blower 1, 2, 3, or 4 fault	Blower is turning at less than the specified minimum RPM. Unit not allowed to run.	Yes
Gas valve 1, 2, 3, or 4 fault	Gas valve is on when it should be off. Unit not allowed to run.	Yes
Low water	Low water probe is in contact with water and low water sensor is not in contact with water.	Yes
XV header flooded (STS systems only)	Float switch in Ultra-sorb Model XV header has detected a flooded header condition	Yes

Continued

Setup menu

Table 49-1: Alarms menu (continued)		
Alarm label	Description	Does alarm auto-clear?
Supply water failure (XT systems only)	No water. Supply water failure, or drain malfunctioning/leaking. Fill has been on for 30 minutes without reaching high water probe or target current. Cycles the fill and drain valves 20 times and retries filling for 10 additional minutes before an alarm is generated. If not corrected, humidifier shuts down.	No
Supply water failure 2 (XT systems only)	No water in right cylinder. See above.	No
Excessive foaming (XT systems only)	Continuous foaming causing a problem. Target current has been reached but is now below the -10% of nominal current, and high water probe has been wet for an extended period of time. – or – Fill was halted because top probe became wet, and current is reduced to 50% of when fill was halted. Humidifier will do a normal drain event. Alarm is generated if this condition occurs 10 times, indicating that foaming is a persistent problem. If not corrected, humidifier shuts down. Cylinder may need to be completely drained twice to prevent foaming. See "Start-up procedure" in <i>XT Electrode Steam Humidifier Installation, Operation, and Maintenance Manual</i> shipped with the humidifier.	No
Excessive foaming 2 (XT systems only)	Continuous foaming causing a problem in right cylinder. See <i>Excessive foaming</i> below.	No
Overcurrent (XT systems only)	Overcurrent; 120% over nominal. Conductivity build-up; drain malfunctioning/plugged; or too much condensate return. Drains up to 12 times to attempt to reduce current: <ul style="list-style-type: none"> • For drains 1 through 6, length of drain is incrementally increased. • For drains 4 through 12, drain valve is cycled ten times to loosen possible debris in drain. • For drains 7 through 12, drain duration is identical to drains 1 through 6, but tempering is pulsed at 5-second intervals. If not corrected, humidifier shuts down.	No
Overcurrent 2 (XT systems only)	Overcurrent; 120% over nominal in right cylinder. See above.	No
Current sensor out of range (XT systems only)	XT current sensor is out of range	Yes
Current sensor 2 out of range (XT systems only)	XT current sensor 2 is out of range	Yes
Notes: <ul style="list-style-type: none"> • See the "Troubleshooting" section, beginning on Page 84, for alarm possible causes and recommended actions. • The Alarms Log displays alarm name, date and time of occurrence, plus "Active," "Cleared" or "Auto-cleared." • Active alarms display first in the Alarms Log, followed by cleared alarms (auto-cleared and/or manually-cleared) listed in order of occurrence. • The Alarms Log displays maximum 30 alarms. Cleared alarms leave the log first. • If an alarm event occurs and is not manually cleared or auto-cleared during unit operation, the alarm will remain until there is demand and the unit is running. 		

Setup menu

The Setup menu is where system parameters can be changed. This menu is used primarily during initial installation, but can also be used for making changes or adjustments as needed during operation. Note that while all parameters can be changed, many changes also require a corresponding hardware change. Vapor-logic4 firmware will warn you of this during the setup process.

See the Pages 28 through 36 for more information about the Setup menu.

PID tuning

When your system has a humidity or dew point transmitter, you can adjust and control the set point through the keypad/display or Web interface using a proportional, integral, and derivative (PID) control loop.

Kp = Proportional gain factor

Ki = Integral gain factor

Kd = Derivative gain factor

Improves humidifier response time

With a PID loop, you can tune your system for maximum performance using the proportional (Kp), integral (Ki), and derivative (Kd) gain terms. These gain factors work in the following way: The overall demand in a PID system is made up of three distinct parts—the proportional, the integral, and the derivative. Each of these parts is calculated and then multiplied by its corresponding gain factor. These gain factors are the setup variables you have access to from the Setup menu. By making a gain factor larger, you increase its overall influence on system demand. Once each PID component is multiplied by its gain factor, all three terms are added together to determine the overall demand percentage.

The proportional term

The proportional term is the difference between the RH set point and the actual humidity multiplied by the proportional gain. For example, with a Kp of 80 and the actual humidity 5% below the RH set point, the proportional contribution to the demand is:
 $5 \times 80 \times 0.085 = 33\%$ (the 0.085 is an internal scalar used to increase the usable span of Kp).

There is a problem with using only proportional gain to control the RH. In almost all applications there is some constant load on the humidifier just as there is a constant load on heating equipment. If the proportional term is all that is used, the actual humidity must be less than the set point for the humidifier to be on.

What happens is the humidifier finds a happy medium where the actual humidity is something less than the set point, which allows the humidifier to continue to run. This difference between the set point and the actual running humidity level is called the droop. This droop can be corrected using the next term, the integral.

PID tuning

The integral term

The integral term is an accumulation of RH error over time multiplied by the integral gain. Every 1/10 second when the demand is updated, the instantaneous RH error (RH set point – actual RH) is added to a temporary variable that accumulates the error. This accumulated error is multiplied by the integral gain to create the integral term. The integral gain affects how fast the humidifier corrects a droop condition. The higher the integral gain (Ki), the faster the reaction. (An integral gain of zero disables this variable and allows the unit to run on the proportional term only.)

With an integral gain term greater than zero and an actual humidity below set point, the demand increases slightly with each update. If the actual humidity is above set point, the demand decreases slightly. The amount it increases or decreases depends on the magnitude of the RH error and the integral gain value. The closer you are to the set point, the smaller the addition or subtraction.

When looking at this control scheme, an interesting pattern occurs. The total demand signal for the humidifier is the sum of the proportional part, the integral part, and the derivative part. As the actual humidity approaches the set point, the integral portion makes up the majority of the demand, and the proportional part makes up very little. Once the set point is reached and the unit stabilizes, the entire demand is made up of the integral part because the proportional part is zero.

If the actual humidity goes over the set point, the integral term starts to decrease. In addition, the proportional term becomes negative and actually starts to subtract from the total system demand. These two terms work in conjunction with each other to bring the humidifier back to set point.

PID tuning

The derivative term

The derivative term is the measured change in error over time multiplied by the derivative gain (differentiating error with respect to time).

If the actual measured RH is below set point and is rising, the derivative term subtracts from the demand in anticipation of the approaching set point.

If the actual measured RH is below set point and is falling, the derivative term adds to the demand in anticipation of the need to get the demand up faster and start climbing toward set point.

If the actual measured RH is above set point and falling, the derivative term adds to the overall demand in anticipation of the approaching set point. It generally is used to increase damping and, in some cases, improves the stability of the system.

However, in the majority of control situations, the derivative term is not needed and is simply set to zero. The proportional term and integral term provide tight, accurate control without the addition of the derivative term.

PID band

The last user-controlled term in the PID equation is the PID band. The PID band defines the range of measured RH values (°F/°C for dew point control) where the PID loop is in operation. The PID loop is in operation when the measured RH is in the range of (RH set point – PID band) to (RH set point + PID band). If the measured RH is below the PID band, the PID calculations are suspended and the demand is set to 100%. Conversely, if the measured RH is above the PID band, the demand is set to 0%.

For example, if starting with an RH set point of 35% and a PID band of 10%, the PID loop operates when the actual humidity is in the range of 25% to 45%. If the actual humidity is lower than 25%, the humidifier is full on. If the actual humidity is above 45%, the humidifier demand is 0%. The PID band aids in speeding the response time of the system. It allows the RH to get somewhat close to the set point and then lets the PID loop precisely control the RH when it is within the PID band. The default value for the PID band is 10%.

Large spaces where the humidification system influences the RH very slowly typically benefit from a smaller PID band. Small spaces where the humidification system can quickly influence the RH typically benefit from a larger PID band. Rarely should it be set to less than 10%.

PID tuning

PID setup tips

A large PID band (10% to 20%) yields tighter and more stable control with longer response times. A small PID band produces quicker response times, but control may become unstable if the RH regularly goes outside the band.

As a rule, start with a PID band of 10%. When the humidifier is operating at steady state, make sure the RH does not go outside the PID band. The intent of the PID band is to quickly get the RH into a controllable range. To increase or decrease the effect of the proportional term on system performance, adjust the proportional gain (K_p).

However, for the majority of systems, the factory default setting of 80 is sufficient. Generally speaking, a large integral gain (K_i) quickens the system response but may cause it to oscillate and become unstable. A small integral gain yields tighter, more stable control at the expense of a long response time.

These principles can be applied in the following examples: If a system eventually reaches the desired RH level but takes a long time to do so without overshooting the set point, faster response can be achieved by increasing the integral gain. If the measured RH oscillates above and below the set point numerous times before finally reaching set point, decrease the integral gain.

Typically, if a large adjustment is made to the integral gain, better response is achieved by decreasing the magnitude of the change. Then, modify the proportional gain slightly in the same direction the integral gain was changed. RH history data, available for download from the Diagnostics menu, can aid when doing PID loop tuning.

Water level control

Probe system

Humidifiers with tap/softened fill water use conductivity probes to measure and control the water level for optimum operating efficiency. Water conductivity must be at least 30 $\mu\text{S}/\text{cm}$ for the probe system to operate. The three-probe system is monitored by the Vapor-logic4 board, which performs all the necessary logic and timing functions to provide total water level control and safety shutdown.

Vapor-logic4 automatically maintains the water level between the top and middle probes (see Figure 55-1). When the water level falls below the middle probe, the fill valve opens until the water level rises to the top probe. Water must remain in contact with the probe surface for three seconds for Vapor-logic4 to determine that the water is at the probe's level.

Conversely, water must stay out of contact with the probe surface for three seconds for Vapor-logic4 to determine that the water is below the probe's level. This three-second delay ensures that turbulence does not cause an incorrect level reading.

Each time the fill valve energizes, the Vapor-logic4 system tests the probe system. If the signal from the probe assembly begins to deteriorate, the "Clean probes" message appears in the Messages Log. Once the probe system reaches its maximum usable life, the humidifier shuts down and the "Faulty water probe" alarm appears.

An adjustable skim time allows for an extended skim period (0 to 120 seconds) to reduce mineral accumulation. When skimming, the fill valve remains energized after the water level reaches the top probe for the amount of time specified by the skim duration. The skim duration is adjustable in one-second intervals through the Setup menu.

If the water level falls below the low-water cutoff probe, heating outputs are disabled; this provides low-water protection for the heating outputs.

See "Chloride corrosion" Caution at right.

XT humidifiers do not use conductivity probes for water level control. See "Electrode steam humidifiers" on Page 57.

CAUTION

Chloride corrosion

Damage caused by chloride corrosion is not covered by your DRI-STEEM warranty. Chloride corrosion can result from a variety of causes, including, but not limited to

- Improper water deionization processes
- Improper water softening processes
- Humidifier's supply water

Figure 55-1:
Water level control for tap/softened water humidifier

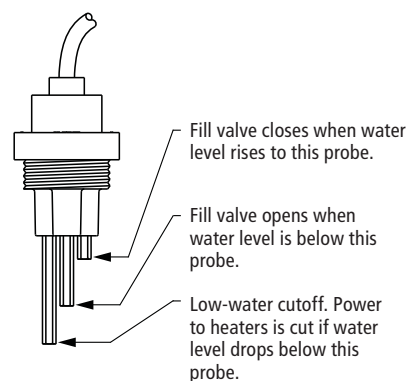

Humidifiers using tap or softened water control water levels electronically using a three-rod probe. The controller responds with the above actions when the water level reaches each rod.

mc_030910_1335

VLC-OM-030

Water level control

XT humidifiers do not use the float valve system for water level control. See "Electrode steam humidifiers" on Page 57.

CAUTION

Chloride corrosion

Damage caused by chloride corrosion is not covered by your DRI-STEEM warranty. Chloride corrosion can result from a variety of causes, including, but not limited to

- Improper water deionization processes
- Improper water softening processes
- Humidifier's supply water

Figure 56-1:
Water level control for DI/RO water systems

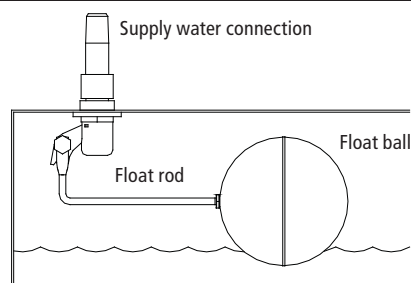

Humidifiers using DI/RO water control water levels using a float valve and low-water cutoff switch.

mc_052710_1644

OM-7396

Figure 56-2:
Low water cutoff switch for DI/RO water systems

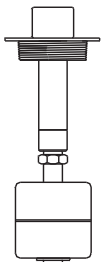

A zero mark on top of the float indicates proper float placement on stem. Switch is normally open when float ball is at its lowest point on the stem.

OM-3009

Float valve system

DI/RO water systems (except for steam injection) use a float valve system to control water levels for optimum operating efficiency. DI/RO systems are used where water/steam purity is important, where demineralized water is needed to improve performance or lessen maintenance requirements, or where a water source has minimal or no conductivity, thus requiring a float rather than a probe to sense water levels.

The float valve system consists of a fill float and a low water cutoff float.

The fill float regulates how much water is added to the tank via a float ball, float arm, and mechanical valve. The valve is adjusted to fill the evaporating chamber within 1/4" (6 mm) of the overflow port allowing heated, and therefore expanded, water at startup to fill the external P-trap.

The low water cutoff float has an electrical switch that closes when a ready water condition is reached. This float switch provides low water protection for the heating outputs. If the water falls below the float, the heating outputs are disabled.

See "Chloride corrosion" Caution at left.

Water level control

Electrode steam humidifiers

In electrode steam humidifiers (see Figure 57-1), steam output is directly related to the resistance of the water in the steam cylinder and, therefore, the conductivity of the water between the electrodes.

Recommended supply water conductivity for XT humidifiers is 125 to 1250 $\mu\text{S}/\text{cm}$.

Higher water levels cover more electrode surface and result in more steam; lower water levels cover less electrode surface and result in less steam. Since water conductivity and water level both correlate to steam output, DRI-STEEM electrode humidifiers employ an algorithm that monitors conductivity and manages drain and fill events to optimize humidifier performance and provide proper steam output.

As the water in the cylinder boils into steam, the concentration of conductive ions increases until it reaches a threshold that triggers a drain and fill event. This rids the cylinder of highly conductive water and replaces it with less conductive fill water. The more conductive the fill water and the higher the demand, the more quickly the threshold is reached, and the more frequently the cylinder automatically drains and fills to stay within the parameters for proper steam output.

To prevent overflowing of the cylinder, filling stops if the water level reaches the high water sensor.

Supply water

Electrode steam humidifiers use tap or softened supply water. Demineralized, deionized, and reverse-osmosis water are not conductive enough for electrode steam humidifiers.

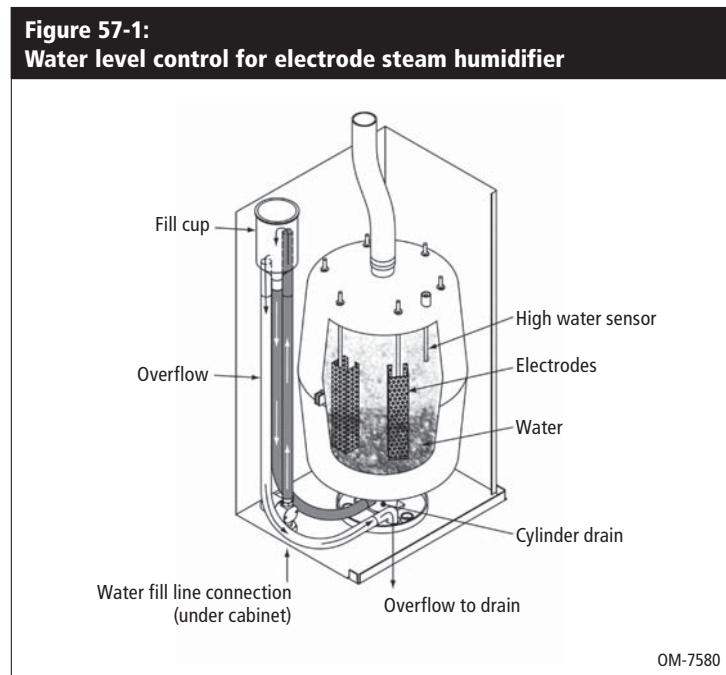

Options and features

When a duct high limit option is ordered, DRI-STEEM provides either a duct high limit switch or a duct high limit humidity transmitter (4 to 20 mA output, 0 to 100% RH range) for duct mounting.

Duct high limit switch option

The duct high limit switch prevents duct saturation by turning off the humidifier when reaching the device set point. When this occurs, a “Duct HL trip” message appears in the Messages Log and autoclears when duct RH drops below the duct high limit set point.

Modulating high limit transmitter option

The modulating high limit transmitter operates in conjunction with the room/duct controlling transmitter or demand signal through the Vapor-logic4 control system to prevent excess humidification in the duct. Vapor-logic4 starts lowering the humidifier output when the duct relative humidity is within a user-defined percentage (default is 5%) of the duct high limit set point. This value is called the duct high limit span and is defined during Setup.

When duct relative humidity enters this range, a “Duct HL span” message appears in the Messages Log and the Message label lights on the keypad/display. If necessary, the reduction of the humidifier output continues until maximum high limit set point is reached, shutting off the humidifier completely. If this occurs, a “Duct HL trip” message appears in the Messages Log.

When the high relative humidity starts to decrease in the duct, Vapor-logic4 slowly starts to increase steam production. When the duct relative humidity decreases to greater than the defined percentage below the duct high limit set point, the control transmitter or signal by others demand signal is restored as the primary controller, returning the control system to normal operation, and the messages in the Messages Log automatically clear.

Temperature compensation control option

Note: This option is not applicable for XT humidifiers.

When selected as an option, DRI-STEEM provides a temperature compensation transmitter. The temperature compensation transmitter continually monitors interior window glass temperature and transmits this temperature to Vapor-logic4.

Vapor-logic4 assumes a 70 °F (21 °C) room temperature and uses the glass temperature and the RH in the space being controlled to calculate the dew point (°F or °C) for the space.

Options and features

If the window temperature falls below the dew point, Vapor-logic4 automatically decreases the RH set point so moisture does not form on windows. The Home screen displays the modified RH set point, and an asterisk (*) appears next to the modified RH set point, denoting that temperature compensation has taken control of the RH set point. The “Temp comp on” message appears in the Messages Log and the Message softkey label becomes highlighted. When the interior window glass temperature rises above the dew point, Vapor-logic4 restores system control to the normal RH set point for the space, and the “Temp comp on” message automatically clears.

The temperature compensation control option is available only when the system is equipped with an RH transmitter. It is not available when a remote humidistat, dew point transmitter, or building automation system is used to control the humidifier.

The transmitter provided with Vapor-logic4 is calibrated for -20°F to 160°F (-29°C to 71°C) with output from 4 to 20 mA. For example, a temperature reading of 70°F (21°C) should produce a measurement of 12 mA. You can calibrate the sensor by adjusting the offset in the auxiliary temp sensor section of the Setup menu.

Auxiliary temperature sensor option

Note: This option is not applicable for XT humidifiers.

When selected as an option, DRI-STEEM provides a temperature sensor for monitoring temperature in a duct or space. Temperature from this sensor can be viewed from the Status menu (“Aux temperature”). Temperature history data is logged to the data log and can be downloaded from the download data section of the Diagnostics menu.

Tank preheat feature

The tank preheat feature heats the water in the tank to near boiling to allow a rapid response to a demand signal. If the tank is cold when a small demand signal is present, the Vapor-logic4 controller overrides the demand signal and heats until the tank temperature increases to the boiling point. At this point, control is returned to the original demand signal.

Preheating allows the system to respond quickly to small demand requests. When preheating, the word “Heating” appears on the Home screen.

Options and features

Aquastat set point feature

Note: This feature is not applicable for XT humidifiers.

The aquastat set point is the minimum tank temperature the Vapor-logic4 controller maintains when there is no call for humidity or when safety circuits are not satisfied (e.g., high limit or airflow proving switch). The aquastat set point is adjusted through the water management section of the Setup menu. This feature shortens the tank preheat time, providing a rapid response to a call for humidity.

For example, if the aquastat is set at 180 °F (82 °C) when a call for humidity occurs, the tank only needs to warm up 32 °F (18 °C) to reach the boiling point. However, if the aquastat is at its minimum default setting of 40 °F (4 °C) and the tank is in an average-temperature occupied room, when a call for humidity occurs, the tank needs to warm up from room temperature to the boiling point before producing steam. When an aquastat call is heating the tank, the word “Heating” appears on the Home screen. Aquastat heating will occur with high-limit and airflow alarm conditions.

Freeze protection

Freeze protection is similar to aquastat operation with some exceptions. The freeze protect set point is fixed at 40 °F (4 °C). Its purpose is to prevent the tank from freezing in cold environments. Unlike aquastat, if a condition exists that prevents the heaters, burners, and valves from firing (such as an alarm, an external interlock switch is open, or the humidifier is in Standby mode), instead of remaining idle, the controller switches to manual drain run mode and the tank drains to prevent freezing. Change mode to Auto to resume operation.

When the tank is heating to prevent freezing, the word “Heating” appears on the Home screen. When the tank is draining or has drained to prevent freezing, the “Freeze drain” message appears in the Messages Log and the Message softkey label becomes highlighted.

Fan-based dispersion operation

If your humidifier is equipped with a Space Distribution Unit (SDU) or an Area-type fan, it is enabled after the Vapor-logic4 controller receives a call for humidity and the tank water is approaching boiling temperature.

When the humidifier no longer receives a call for humidity, it stops heating and the SDU or Area-type fan continues to run for the time delay period (as defined in the fan-based dispersion section Setup menu).

Options and features

Sensor offsets

All external transmitters shipped with Vapor-logic4 can be field calibrated from the Setup menu. For example, if the system is equipped with an RH transmitter, there is an RH offset setting.

The factory default for all transmitter offset settings is zero. The sensors that have this adjustment capability are the humidity, duct high limit, temperature compensation, and dew point transmitters.

Automatic drain sequence, tap/softened water

(See note at right for XT humidifiers.)

When configured to run a tap/softened water humidifier with an automatic drain valve, Vapor-logic4 uses an automatic drain sequence (ADS) to reduce mineral accumulation in the tank and drain line, which decreases tank maintenance.

The automatic drain sequence starts by opening the drain valve to empty the tank. When the drain duration ends, the fill and drain valves remain open to flush the tank. When the flush duration ends, the automatic drain sequence is complete and the humidifier resumes normal operation. The default drain and flush durations are model-specific and can be adjusted in the water management section of the Setup menu.

Automatic draining and flushing parameters are defined in the water management section of the Setup menu:

- First, automatic draining and flushing must be enabled.
- Second, the amount of water converted to steam before an automatic drain sequence begins must be defined (Usage). Defaults for this value are model-specific and are calculated based on operating 200 hours at 100% capacity. Go to the Setup menu to view or change this setting for your humidifier.
- Third, days of the week when the automatic drain sequence can occur must be defined. This means that once the Usage requirement is met, the automatic drain sequence can occur on the first allowed day (allowed days default is all days).
- Last, time of day when the automatic drain sequence occurs must be defined (default value is midnight).

For example, if you use factory default settings for the automatic drain sequence, the first automatic drain sequence will occur at midnight on any day of the week once the model-specific usage requirement has been met. If you want to change these settings, go to the water management section of the Setup menu.

Note that the automatic drain sequence is designed for a tap/softened water humidifier with electric drain and fill valves. Humidifiers using DI/RO water do not require automatic draining and flushing, but this feature can be enabled if the humidifier has electric drain and fill valves.

Drain algorithm for XT humidifiers

XT humidifiers employ a drain algorithm that is written specifically for how electrode steam humidifiers function. See "Electrode steam humidifiers" on Page 57.

Options and features

Draining when using softened water

When using softened water, draining occurs for a one-minute duration after a period of time based on 1000 hours of 100% operation to remove residue from the drain valve mechanism. End-of-season draining occurs as described below.

Skim timer

With a tap/softened water configuration, the Vapor-logic4 controller has a skim timer. This timer is activated at the end of each fill cycle. The timer keeps the fill valve open (for a user-determined amount of time after the tank has filled) to skim minerals off the water surface. The skim time is adjusted through the Setup menu.

End-of-season drain

If there is no call for humidity for a user-defined time period, the humidifier performs an end-of-season (EOS) drain where the drain valve remains open for ten hours to allow the tank to drain and then closes. If the humidifier receives a call for humidity after the ten-hour end-of-season drain-down period has begun, the controller stops the end-of-season draining, the tank refills, and the humidifier resumes normal operation. The user-defined inactivity time period (idle time) is defined in the end-of-season drain section of the Setup menu. This option is available only on units equipped with electric drain and fill valves.

Service interval

The Vapor-logic4 controller tracks the amount of water converted to steam by the humidifier and the number of hours the humidifier runs. When the amount of steam or hours of run time exceeds the user-defined service interval (pounds, kilograms, or hours, adjusted in the Setup menu), “Service unit” appears in the Messages Log.

The humidifier continues to operate after the message appears. The message notifies the user that the service interval was reached and the humidifier should be cleaned. The message remains in the Messages Log until it is cleared or until the Messages Log adds 10 new messages (the maximum number of messages the log holds).

Options and features

Setting date and time

The Vapor-logic4 controller contains a real-time clock that is used for several features including the drain and flush sequence and alarm logging. If you need to reset the date or time, go to the Setup menu. The date and time will need to be reset whenever the Vapor-logic4 controller has been powered off for more than 72 hours, such as when starting up at the beginning of the humidification season.

Note: Verify the date and time settings after every firmware upgrade.

Battery backup, nonvolatile memory

If there is a power outage, date and time settings will be saved for 72 hours. Alarms, unit configuration, and usage timers will remain in nonvolatile memory indefinitely.

Security/password

To control who can change Vapor-logic4 settings, enable the security function and define a password in the Setup menu. Enter four digits, numbers only, and define the time-out period (minutes of inactivity before Vapor-logic4 reverts to read-only mode). The Web interface and the keypad/display can have separate passwords.

Important: Write down the password and keep in a secure location.

Options and features

Note: Data is saved to nonvolatile memory every 60 minutes. If unit power is lost, up to 60 minutes of data could be lost.

Downloading historical data

Vapor-logic4 acquires data at one-minute intervals and retains it for seven rolling days. These data, available for download and sorting, contain the details shown in Table 64-1.

Go to the **Download data** section of the Diagnostic screen for download options.

Table 64-1:
Sample of data log downloaded and sorted

Time	SpaceRH or Demand	Aux Temp (degF)	Tank Temp (degF)	BTU's used	Lbs steam	Output (pcnt)	Alarm/Msg	Alarm/Msg Status	Current Config: xx##xx#x###xx	Factory Config: xx##xx#x###xx
1/26/10 9:36 AM	23	0	212	567019018	421066	23			—	—
1/26/10 9:37 AM	23	0	212	567021350	421068	23				
1/26/10 9:38 AM	23	0	211	567023681	421070	23				
1/26/10 9:39 AM							LOW WATER CUTOUT	Auto cleared message		
1/26/10 9:40 AM	23	0	210	567028344	421073	23				
1/26/10 9:41 AM	23	0	211	567030677	421075	23				
1/26/10 9:42 AM	23	0	212	567033008	421077	23				
1/26/10 9:43 AM	23	0	212	567035339	421079	23				
1/26/10 9:44 AM							Unit Start	Auto cleared message		

To sort data (as shown above) with alarms and messages listed in the order they occurred:

1. Import the data into a spreadsheet program, such as Microsoft Excel.
2. Set the Time column to be displayed in the date-time format.
3. Sort all rows by “Time” in ascending order.

Backing up and restoring data

Vapor-logic4 data can be backed up to and restored from a USB flash drive. The backup file contains all information relative to the humidifier, including firmware, user settings, model number, serial number, and the configuration string.

Backup files use the serial number in the backup file name so that the file is easily matched to a particular humidifier.

Firmware updates

To create a backup file:

1. Insert a FAT32-formatted USB flash drive into the USB port on the Vapor-logic4 board.
2. Go to Diagnostics/USB backup-restore/Back up settings
3. Select Yes. The display will prompt you when backup is complete.

To restore from a backup file:

1. Insert a FAT32-formatted USB flash drive with that humidifier's backup file into the USB port on the Vapor-logic4 board.
2. Go to Diagnostics/USB backup-restore/Restore settings.
3. Select Yes. Note that the serial number of the humidifier and backup file must match to complete the restore process.

Downloading firmware updates

The Vapor-logic4 controller can be field upgraded to the latest firmware version via the USB port on the Vapor-logic4 board. Firmware updates are available for free on the DRI-STEEM website.

To update your Vapor-logic4 controller to the latest firmware version, perform the following procedure:

1. Navigate to the Vapor-logic4 page at www.dristeem.com, or type the following into your browser's address bar:
www.dristeem.com/products_ControllerAccess_VL4.jsp
2. Click the **Firmware updates** link on the Vapor-logic4 page.
3. Plug a reliable USB flash drive into a USB port on your computer, and prepare the flash drive as follows:
 - a) Move or delete all files from the drive.
 - b) Make sure it has at least 16 MB of free space.
 - c) Make sure it is not partitioned into multiple drives.
4. Perform the procedure in Table 66-1.

Firmware updates

Table 66-1:
Downloading Vapor-logic4 firmware updates

1. Click the link shown to the right on the Vapor-logic4 firmware updates page of www.dristeem.com.

If a security window appears, click the **Save** button.

Note: The screenshots in this table depict typical Internet Explorer screens in Windows XP. While your browser and operating system might be set up differently, the screenshots are provided as a general road map.

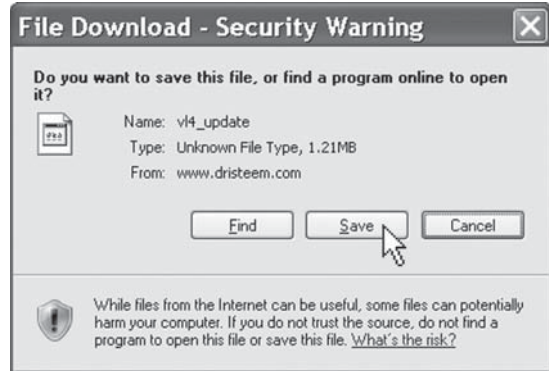
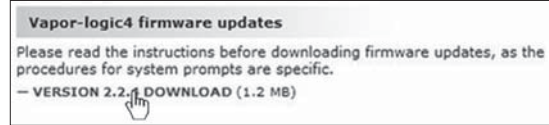

2. When prompted for a save location, choose your desktop.
3. Click the **Save** button.

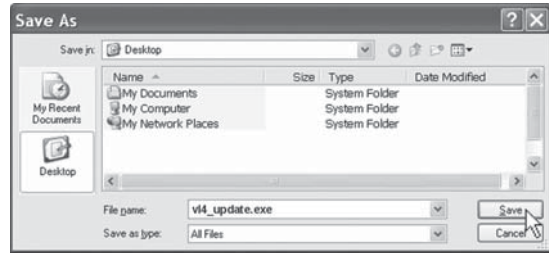

4. On your desktop, double-click the new v14_update.exe file.



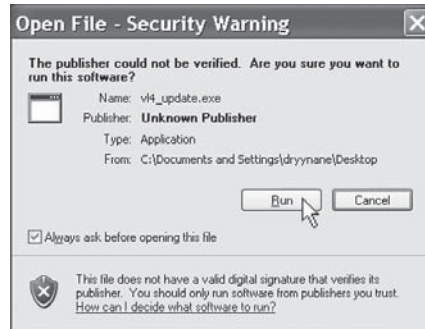

5. If a Security Warning appears, click the **Run** button.
- A WinZip Self-Extractor window appears.

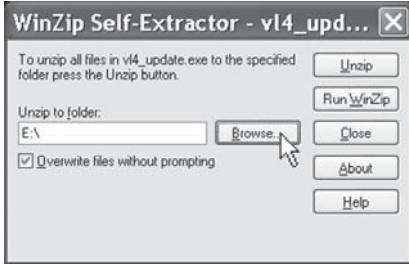
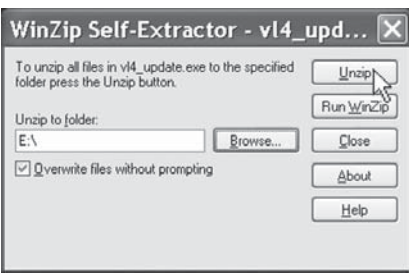

Continued

Firmware updates

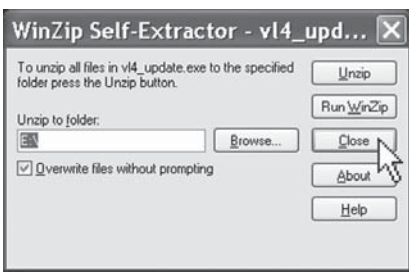
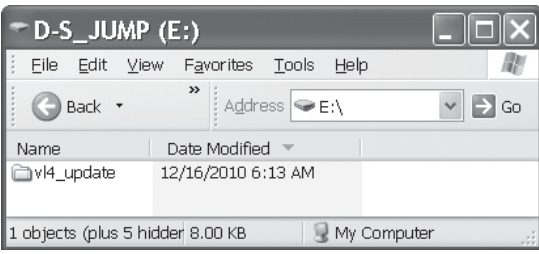
Table 66-1: Downloading Vapor-logic4 firmware updates (continued)	
<p>6. Click the Browse button in the WinZip Self-Extractor window, and select your USB flash drive as the target location.</p>	
<p>7. Click the Unzip button in the WinZip Self-Extractor window.</p> <p>A WinZip window opens to confirm that the firmware update has been unzipped.</p>	
<p>8. Click the OK button.</p>	
<p>9. Click the Close button to close the WinZip Self-Extractor window.</p>	
<p>10. Open your USB flash drive. Confirm that it contains a folder named v14_update, and that it has today's timestamp.</p>	
<p>11. Remove the USB flash drive from your computer.</p> <p>12. Proceed to "Installing firmware updates" on Page 68.</p>	

mc_121610_0530

Firmware updates

 **WARNING**

Electric shock hazard

All circuits must be energized for this firmware update procedure. Contact with energized circuits can cause severe personal injury or death as a result of electric shock.

To prevent shock when grounding to the electrical subpanel, touch the subpanel along its edge, away from wires and components.

mc_072209_1320

Installing firmware updates

Note: For mission-critical applications, DRI-STEEM recommends that you have a spare Vapor-logic4 board on hand before updating.

1. Place the humidifier system in Standby mode.
2. **IMPORTANT:** To prevent static damage to the USB flash drive and controller, ground yourself by briefly touching the humidifier’s electrical subpanel before touching any part of the controller board or doing Step 3. See the Warning at left.
3. Insert the USB flash drive loaded with the unzipped firmware update folder into the Vapor-logic4 board USB port.

CAUTION

Do not remove USB flash drive or cycle power early

During Steps 4 through 6, do not remove the USB flash drive or cycle the power until the signal occurs as explained in Step 6. Doing either one prematurely could corrupt the update and render the board inoperable.

4. Disconnect power to the Vapor-logic4 board, wait five seconds, and reconnect power.
5. Wait for a relay on the Vapor-logic4 board to begin clicking continuously. It could take anywhere from several seconds to over two minutes.

IMPORTANT: If the keypad/display begins to blink continuously while waiting, disconnect power to the Vapor-logic4 board, wait five seconds, and reconnect power. Then go to Step 6.

6. When the relay on the Vapor-logic4 board begins to click continuously, remove the USB flash drive from the Vapor-logic4 board USB port.

When the USB flash drive is removed, the Vapor-logic4 controller and display reboot with the updated firmware.

7. Verify the update by checking the Vapor-logic4 firmware version as follows:
 - a) Select Diagnostics in the keypad/display Main menu
 - b) Select Humidifier info.
 - c) Scroll down to Firmware version.

The firmware version displayed should match the version number of the **vl4vx.x.x file in the vl4_update** folder on the USB flash drive.

8. Update the clock/calendar to today’s date.
9. Verify humidifier operation, and return it to service.

Cycling power with USB flash drive inserted

Every time power is cycled while the USB flash drive is inserted, the update process repeats and must be allowed to complete before the USB flash drive is removed or power is cycled again. Doing either one prematurely could corrupt the update and render the board inoperable. If in doubt, wait five minutes after power is turned on before cycling power or removing the USB flash drive.

Test outputs and test run

Not all USB drives perform equally. If a USB flash drive fails to update the Vapor-logic4 firmware, perform the following procedure with a different USB flash drive:

1. Prepare a new flash drive as described in Step 3 of “Downloading firmware updates” on Page 65.
2. Repeat Steps 4 through 11 in Table 66-1.
3. Repeat Steps 1 through 7 on Page 68.

mc_120210_1235

Test outputs

When completing an installation or repair, cycle all outputs, such as fill valve, drain valve, etc., to verify operation. Go to the test outputs section of the Diagnostics menu and scroll through each connected output to verify operation. During testing, the humidifier mode changes to Standby and the tank status changes to Test.

Test run

Vapor-logic4 has a test run capability to confirm system functionality. This capability allows a technician to simulate a demand for steam production when there isn't one (such as when performing routine maintenance). To confirm functionality, go to the test run section of the Diagnostics menu. Set system demand percent and set test run time duration. During testing, the humidifier mode changes to Standby and the tank status changes to Test.

mc_102108_1350

Modbus, BACnet, LonTalk interoperability

**Figure 70-1:
LON ProtoCessor module installation**

1. Remove LON ProtoCessor module from box.

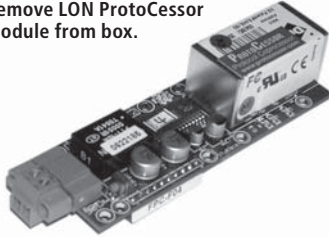

2. Insert LON ProtoCessor module into pins on Vapor-logic4 board.

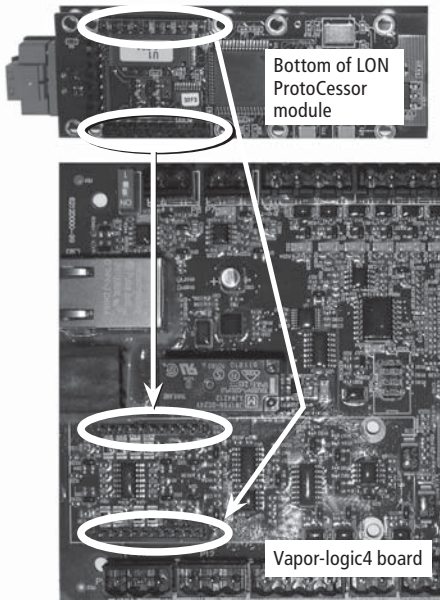

3. Connect wiring from LonTalk system to LON ProtoCessor module on Vapor-logic4 board.

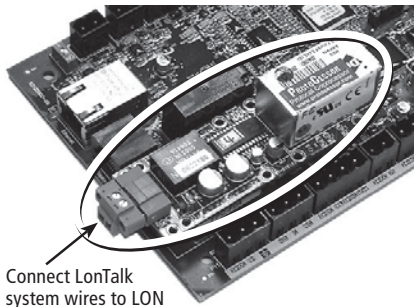

Connect LonTalk system wires to LON ProtoCessor module here.

NOTE: Orient the LON ProtoCessor module as shown, with wire connectors end at the side of the Vapor-logic 4 board.

Vapor-logic4 comes standard with Modbus, or with BACnet or LonTalk if ordered. Vapor-logic4 can connect to building automation systems using these protocols. Variables are defined in the tables on the following pages.

Note: For retrofit BACnet or LonTalk installations, contact your local DRI-STEEM representative or DRI-STEEM to purchase a BACnet or LonTalk upgrade.

Connections

1. If connecting to a Modbus or BACnet MS/TP system, connect Modbus or BACnet system wiring to terminal P7 on the Vapor-logic4 board (positive to positive, negative to negative). If connecting to a BACnet/IP system, connect BACnet system wiring to the Ethernet connection.
2. If connecting to a LonTalk system, connect the LON ProtoCessor module per Step 3 in Figure 70-1.
3. Disconnect power to the Vapor-logic4 board, wait 5 seconds, and reconnect power.
4. Set up communication with Vapor-logic4 using your Modbus, BACnet, or LonTalk network manager, referencing Table 71-1.

Installing LonTalk as a retrofit

1. Turn off power to the unit.
2. Touch the unit's bare metal frame before handling the LON ProtoCessor module, and hold onto frame while handling the module.
3. While handling the module, hold it by the edge. Avoid touching the components or circuit board.
4. Plug LON ProtoCessor module into mounting pins (as shown in Figure 70-1) with LonTalk connector at the edge of the board. Make sure all pins are seated in the connector.
5. Connect LonTalk system wires to LON ProtoCessor module as shown in Step 3 at right.
6. Turn on power to the unit.
7. Use either the keypad/display or Web interface go to the Communications section of the Setup menu to enable LonTalk communication.
8. Set up communication with Vapor-logic4 using your LonTalk network manager, referencing Table 71-1.

Installing BACnet as a retrofit

1. Using the keypad/display or Web interface, go to the Setup menu, and select Tank Setup, then Communication, then BACnet, and press Enter.
2. Enter the code provided when you purchased the BACnet upgrade. The activation code is matched to the unit's serial number.
3. Select the BACnet communication channel in the BACnet Setup menu.
4. Cycle the power to activate BACnet.

Modbus, BACnet, LonTalk interoperability

Table 71-1: Interoperability variable and object names									
Variable name and BACnet object name	Read Only (RO) or Read Write (RW)	Modbus register number*	BACnet Object Type and Instance	LonTalk variable names**	Description	Units		Range	
						I-P units	SI units	I-P units	SI units
Read-only analog variables									
Space_RH	RO	IR-1 30001	AI-01	nvoSpaceRH	Relative humidity content of the air in the space being humidified.	%	%	0 to 100	0 to 100
Space_dew_point	RO	IR-2 30002	AI-02	nvoSpaceDewPoint	Dew point of the air in the space being humidified.	°F	°C	20 to 80	-6 to 26
Duct_RH	RO	IR-3 30003	AI-03	nvoDuctRH	Relative humidity content of the air in the duct.	%	%	0 to 100	0 to 100
Steam_demand_mass	RO	IR-4 30004	AI-04	nvoSteamDmndMass	Steam demand in pounds or kilograms per hour.	lbs/hr	kg/h	0 to 100,000	0 to 100,000
Steam_demand_percent	RO	IR-5 30005	AI-05	nvoSteamDemand%	Steam demand as a percentage of the humidifier's total capacity.	%	%	0 to 100	0 to 100
Aux_temp	RO	IR-6 30006	AI-06	nvoAuxTemp	Temperature of the auxiliary temperature sensor.	°F	°C	-20 to 160	-29 to 170
Tank_temp	RO	IR-7 30007	AI-07	nvoTankTemp	Temperature of the water in the humidifier's evaporating chamber.	°F	°C	-240 to 265	-151 to 129
Steam_output_mass	RO	IR-8 30008	AV-1	nvoSteamOutMass	Estimated amount of steam the humidifier is producing in pounds or kilograms per hour.	lbs/hr	kg/h	0 to 100,000	0 to 100,000
Steam_output_percent	RO	IR-9 30009	AV-2	nvoSteamOutput%	Estimated amount of steam the humidifier is producing as a percentage of the humidifier's total capacity.	%	&	0 to 100	0 to 100
Water_until_ADS	RO	IR-10 30010	AV-3	nvoWaterUntilADS	Pounds or kilograms of water remaining to be converted to steam before the next automatic drain sequence (ADS) cycle.	100 lbs	100 kg	0 to 2,200,000	0 to 1,000,000
Water_until_service	RO	IR-11 30011	AV-4	nvoWaterTilSrvc	Pounds or kilograms of water remaining to be converted to steam before the next service cycle.	100 lbs	100 kg	0 to 2,200,000	0 to 1,000,000
Current_1 (XT systems only)	RO	IR-26 30026	AI-10	nvoXT_current1	XT operating current	Amps	Amps	0 to 100	0 to 100
Current_2 (XT systems only)	RO	IR-27 30027	AI-11	nvoXT_current2	XT operating current, right cylinder	Amps	Amps	0 to 100	0 to 100
* See Note 1 on Page 76.									
** See Note 2 on Page 76.									

Continued

Modbus, BACnet, LonTalk interoperability

**Table 71-1:
Interoperability variable and object names (continued)**

Variable name and BACnet object name	Read Only (RO) or Read Write (RW)	Modbus register number*	BACnet Object Type and Instance	LonTalk variable names**	Description	Units		Range	
						I-P units	SI units	I-P units	SI units
Setup variables									
Run_mode	Write	HR-1 40001	MSV-01	nviRunMode	Mode of the unit or system. The defined options are: 1 Auto 2 Local standby 3 System standby 4 Manual drain	--	--	1 to 4	1 to 4
	Read	HR-1 40001	MSV-01	nvoRunMode	Mode of the unit or system. The defined options are: 1 Auto 2 Local standby 3 System standby 4 Manual drain 5 Test outputs 6 Test run	--	--	1 to 6	1 to 6
Space_RH_set_point	Write	HR-2 40002	AV-05	nviSpaceRHsetPt	Humidity set point for the space being humidified.	%	%	0 to 100	0 to 100
	Read	HR-2 40002	AV-05	nvoSpaceRHsetPt		%	%	0 to 100	0 to 100
Space_dew_point_set_point	Write	HR-3 40003	AV-06	nviSpaceDewPtSP	Dew point set point for the space being humidified.	°F	°C	20 to 80	-6 to 26
	Read	HR-3 40003	AV-06	nvoSpaceDewPtSP		°F	°C	20 to 80	-6 to 26
Duct_high_limit_set_point	Write	HR-4 40004	AV-07	nviDuctHLsetPt	Duct high limit set point.	%	%	0 to 100	0 to 100
	Read	HR-4 40004	AV-07	nvoDuctHLsetPt		%	%	0 to 100	0 to 100
Fieldbus_demand_mass	Write Only	HR-5 40005	AV-08	nviFbusDemndMass	Steam output (as demanded via the fieldbus) as a percentage of the humidifier's total capacity.	lbs/hr	kg/h	0 to 100,000	0 to 100,000
Fieldbus_demand_%	Write Only	HR-6 40006	AV-09	nviFldBusDemand%	Steam output (as demanded via fieldbus) in pounds or kilograms per hour. If the request exceeds the unit's capacity, the unit will run at 100% capacity.	%	%	0 to 100	0 to 100
PID_band	RW	HR-7 40007	AV-10	nciPIDband	PID band.	%	%	0 to 50	0 to 50
PID-Kp	RW	HR-8 40008	AV-11	nciPIDkp	PID-Kp (proportional gain) factor.	--	--	0 to 1000	0 to 1000
PID-Ki	RW	HR-9 40009	AV-12	nciPIDki	PID-Ki (integral gain) factor.	--	--	0 to 1000	0 to 1000
PID-Kd	RW	HR-10 40010	AV-13	nciPIDkd	PID-Kp (derivative gain) factor.	--	--	0 to 1000	0 to 1000
* See Note 1 on Page 76. ** See Note 2 on Page 76.									

Continued

Modbus, BACnet, LonTalk interoperability

Table 71-1: Interoperability variable and object names (continued)									
Variable name and BACnet object name	Read Only (RO) or Read Write (RW)	Modbus register number*	BACnet Object Type and Instance	LonTalk variable names**	Description	Units		Range	
						I-P units	SI units	I-P units	SI units
Read-only digital I/O									
Airflow_proving_switch	RO	DI-1 10001	BI-01	nvoAirflowSwitch	0=Open; 1=Closed	--	--	--	--
Duct_HL_switch	RO	DI-2 10002	BI-02	nvoDuctHLswitch	0=Open; 1=Closed				
Safety_interlock	RO	DI-3 10003	BI-03	nvoSafetyI-lock	0=Open; 1=Closed				
Combustion_air_damper_(GTS)	RO	DI-4 10004	BI-04	nvoCombustAirDmp	0=Damper Closed; 1=Damper Open				
Flue_pressure_switch_(GTS)	RO	DI-5 10005	BI-05	nvoFluePressurSw	0=Open; 1=Closed				
Power_vent_switch_(GTS)	RO	DI-6 10006	BI-06	nvoPowerVentSwch	0=Vent Off; 1=Vent On				
XV_header_status_(STS)	RO	DI-6 10006	BI-06	nvoPowerVentSwch	0=Ready; 1=Not ready				
Low_water_sensor_(GTS)	RO	DI-7 10007	BI-07	nvoLowWaterSensr	0=No Water; 1=Water				
Fill_valve	RO	DI-8 10008	BO-01	nvoFillValve	0=Closed; 1=Open				
Drain_valve	RO	DI-9 10009	BO-02	nvoDrainValve	0=Not Draining; 1=Draining				
Active_fault_exists	RO	DI-10 10010	BI-08	nvoMT_AlarmSomewhere	0=No; 1=Yes				
Active_message_exists	RO	DI-11 10011	BI-09	nvoMT_MsgSomewhere	0=No; 1=Yes				
High_water_sensor	RO	DI-12 10012	BI-10	nvoXT_highwater1	0=No Water; 1=Water				
High_water_sensor_2	RO	DI-13 10013	BI-11	nvoXT_Highwater2	0=No Water; 1=Water	Right cylinder, 2-cylinder XT systems only			
Faults and alarms									
Active_messages_exist	RO	DV-1 1	BV-01	nvoMessages	Obsolete with firmware version 2.3.5	--	--	--	--
Active_auto_cleared_alarms_exist	RO	DV-2 2	BV-02	nvoAlarms1					
Active_manually_cleared_alarms_exist	RO	DV-3 3	BV-03	nvoAlarms2					
Clear_all_faults	RW	DV-4 4	BV-04	nviClearAllFaults	When set will clear all active faults				
Alarm_tank_temp_sensor_failed	RW	DV-5 5	BV-05	nvoAlrmTnkTmpSen	See Alarms menu.				
Alarm_tank_overtemp	RW	DV-6 6	BV-06	nvoAlrmOvertemp	See Alarms menu.				
Alarm_RH_signal_out_of_range	RW	DV-7 7	BV-07	nvoAlrmRHsignal	See Alarms menu.				
Alarm_dew_pt_sig_out_of_range				nvoAlrmDewPtSgnl	See Alarms menu.				
* See Note 1 on Page 76. ** See Note 2 on Page 76.									

Continued

Modbus, BACnet, LonTalk interoperability

**Table 71-1:
Interoperability variable and object names (continued)**

Variable name and BACnet object name	Read Only (RO) or Read Write (RW)	Modbus register number*	BACnet Object Type and Instance	LonTalk variable names**	Description	Units		Range	
						I-P units	SI units	I-P units	SI units
Faults and alarms (cont.)									
Alarm_demand_sig_out_of_range	RW	DV-77	BV-07	nvoAlrmDemndSgnl	See Table 49-1, Alarms menu	--	--	--	--
Alarm_duct_RH_sig_out_of_range	RW	DV-88	BV-08	nvoAlrmDuctRHsig					
Alarm_aux_temp_sens_out_of_rnge	RW	DV-99	BV-09	nvoAlrmAuxTemp					
Alarm_water_probe_miswired	RW	DV-1010	BV-10	nvoAlrmProbeWire					
Alarm_water_probe_failed	RW	DV-1111	BV-11	nvoAlrmProbeFail					
Alarm_excess_fill_time	RW	DV-1212	BV-12	nvoAlrmFillTime					
Alarm_excess_refill_time	RW	DV-1313	BV-13	nvoAlrmRefilTime					
Alarm_tank_not_draining	RW	DV-1414	BV-14	nvoAlrmNoDrain					
Alarm_excess_water_no_demand	RW	DV-1515	BV-15	nvoAlrmXessWater					
Alarm_no_SDU_airflow	RW	DV-1616	BV-16	nvoAlrmNoSDUair					
Alarm_no_power_vent_airflow	RW	DV-1717	BV-17	nvoAlrmPrVentAir					
Alarm_no_combustion_airflow	RW	DV-1818	BV-18	nvoAlrmNoCombAir					
Alarm_blocked_flue	RW	DV-1919	BV-19	nvoAlrmBlockdFlu					
Alarm_burner_1_failed	RW	DV-2020	BV-20	nvoAlrmBurner1					
Alarm_burner_2_failed	RW	DV-2121	BV-21	nvoAlrmBurner2					
Alarm_burner_3_failed	RW	DV-2222	BV-22	nvoAlrmBurner3					
Alarm_burner_4_failed	RW	DV-2323	BV-23	nvoAlrmBurner4					
Alarm_ignition_module_1_failed	RW	DV-2424	BV-24	nvoAlrmIgnitMod1					
Alarm_ignition_module_2_failed	RW	DV-2525	BV-25	nvoAlrmIgnitMod2					
Alarm_ignition_module_3_failed	RW	DV-2626	BV-26	nvoAlrmIgnitMod3					
Alarm_ignition_module_4_failed	RW	DV-2727	BV-27	nvoAlrmIgnitMod4					
Alarm_blower_1_failed	RW	DV-2828	BV-28	nvoAlrmBlower1					

* See Note 1 on Page 76.

** See Note 2 on Page 76.

Continued

Modbus, BACnet, LonTalk interoperability

Table 71-1: Interoperability variable and object names (continued)									
Variable name and BACnet object name	Read Only (RO) or Read Write (RW)	Modbus register number*	BACnet Object Type and Instance	LonTalk variable names**	Description	Units		Range	
						I-P units	SI units	I-P units	SI units
Faults and alarms (cont.)									
Alarm_blower_2_failed	RW	DV-29 29	BV-29	nvoAlrmBlower2	See Table 49-1, Alarms menu	--	--	--	--
Alarm_blower_3_failed	RW	DV-30 30	BV-30	nvoAlrmBlower3					
Alarm_blower_4_failed	RW	DV-31 31	BV-31	nvoAlrmBlower4					
Alarm_gas_valve_1_failed	RW	DV-32 32	BV-32	nvoAlrmGasValve1					
Alarm_gas_valve_2_failed	RW	DV-33 33	BV-33	nvoAlrmGasValve2					
Alarm_gas_valve_3_failed	RW	DV-34 34	BV-34	nvoAlrmGasValve3					
Alarm_gas_valve_4_failed	RW	DV-35 35	BV-35	nvoAlrmGasValve4					
Alarm_low_water	RW	DV-36 36	BV-36	nvoAlrmLowWater					
Alarm_foaming_fault_2	RW	DV-37 37	BV-37	nvoAlrmFoaming2					
Alarm_Current_Sense1_Out_Of_Range	RW	DV-51 51	BV-51	nvoAlrmCurSense1					
Alarm_Current_Sense2_Out_Of_Range	RW	DV-52 52	BV-52	nvoAlrmCurSense2					
Alarm_Overcurrent	RW	DV-53 53	BV-53	nvoAlrmOverCur1					
Alarm_Supply_Water	RW	DV-54 54	BV-54	nvoAlrmSupplyH201					
Alarm_Foaming_Fault	RW	DV-55 55	BV-55	nvoAlrmFoaming1					
Alarm_Overcurrent_2	RW	DV-57 57	BV-57	nvoAlrmSupplyH202					
Alarm_Supply_Water_2	RW	DV-58 58	BV-58	nnvoAlrmSupplyH202					
* See Note 1 on Page 76. ** See Note 2 on Page 76.									

Continued

Modbus, BACnet, LonTalk interoperability

**Table 71-1:
Interoperability variable and object names (continued)**

Variable name and BACnet object name	Read Only (RO) or Read Write (RW)	Modbus register number*	BACnet Object Type and Instance	LonTalk variable names**	Description	Units		Range	
						I-P units	SI units	I-P units	SI units
Messages									
Message_Check_Cylinder	RW	DV-56 56	BV-56	nvoMsgChkCyl1	See Table 45-1, Diagnostics menu	--	--	--	--
Message_Check_Cylinder_2	RW	DV-59 59	BV-59	nvoMsgChkCyl2					
Message_replace_contactors	RW	DV-38 38	BV-38	nvoMsgReplCntctr					
Message_service_unit	RW	DV-39 39	BV-39	nvoMsgSrviceUnit					
Message_drain_pending	RW	DV-40 40	BV-40	nvoMsgDrainPend					
Message_no_duct_airflow	RW	DV-41 41	BV-41	nvoMsgNoDuctAir					
Message_interlock_open	RW	DV-42 42	BV-42	nvoMsgIllockOpen					
Message_freeze_prevent_draining	RW	DV-43 43	BV-43	nvoMsgFreezDrain					
Message_end-of-season_active	RW	DV-44 44	BV-44	nvoMsgEOSactive					
Message_temp_comp_on	RW	DV-45 45	BV-45	nvoMsgTempCompOn					
Message_clean_probes	RW	DV-46 46	BV-46	nvoMsgCleanProbe					
Message_duct_HL_trip	RW	DV-47 47	BV-47	nvoMsgDuctHLtrip					
Message_duct_HL_span	RW	DV-48 48	BV-48	nvoMsgDuctHLspan					
Message_insufficient_water	RW	DV-49 49	BV-49	nvoMsgH2Ocutout					
Message_boiling_temp_calibrated	RW	DV-50 50	BV-50	nvoMsgBoilTempCl					
Notes: 1. Modbus Input Registers (IR1-IR11) 16 bit read only Modbus Holding Registers (HR1-HR10) 16 bit read/write Modbus Discrete Input Registers (DI1-DI9) single bit read only Modbus Coil Registers (DV1-DV50) single bit read/write 2. nvi LonTalk SNVTs are write-only; nvo are read-only									

Multiple-tank operation: Introduction and priority groups

Multi-tank mode defined

In multi-tank mode, one Vapor-logic4 controller can control multiple humidifier tanks, and tanks in a multi-tank system can vary by energy source and capacity.

A multi-tank system has one master controller controlling up to 16 slave tanks. The master controller receives the demand signal and controls slave tank steam production based on

- priority group,
- wear leveling,
- fault status.

The master controller also gives permission to slave humidifier tanks to perform functions, such as draining and flushing.

The master controller must be

- field-wired to all required control input signals,
- connected to all slave tanks via the DRI-STEEM fieldbus,
- powered during system operation.

Multi-tank control interface

Most systems have one Vapor-logic4 keypad per multi-tank group. This keypad ships with the tank that has the master control board. The keypad (or the Web interface; see note below) can be connected to any humidifier in the multi-tank group. Maximum cable length from the keypad to any control board in the multi-tank group is 500' (152 m).

Note: Multi-tank groups can also be operated using the Web interface. See “Multi-tank operation with Web interface” on Page 81.

Start-up order and trim tanks

All humidifier tanks in a multi-tank group are factory-assigned to a priority group. There are four priority groups: 0, 1, 2, and 3.

Priority groups identify tank function as follows:

- | | |
|-----------------------------|-----------------------------|
| 0 = Trim tanks | 2 = Priority 2 tanks (peak) |
| 1 = Priority 1 tanks (load) | 3 = Redundant tank |

- **Priority groups identify start-up order:**

Tanks in priority group 0 are brought online first, followed by tanks in priority group 1, then 2. Priority group 3 designates an optional redundant tank, which comes online only if a tank in the system is unavailable and the remaining tanks cannot meet capacity.

- **Trim tank responds first:**

A trim tank is assigned to priority group 0 and is brought online first — always before tanks in priority groups 1, 2, or 3. The trim tank modulates continuously, responding to system demand changes.

Multi-tank groups requiring a rapid response to changes in system demand typically have an electric element humidifier with SSR control as the trim tank.

Staging multiple XT humidifiers

XT humidifiers do not operate in multi-tank mode; however, up to four XT humidifiers can be staged to operate in sequence.

See “Staging multiple XT humidifiers” on Page 37.

Multiple-tank operation: Priority groups

Configuration tips

- Use priority groups 1 and 2 to group tanks for maximum energy efficiency. For example, put gas-fired tanks in group 1 and electric tanks in group 2.
- Multiple small-capacity tanks usually operate more efficiently than one large-capacity tank meeting the same load requirement.
- Use priority groups 1 and 2 to group tanks by capacity, bringing tanks online in the order that best matches humidification load to individual tank capacities.
- If your multi-tank system has a redundant tank, configure that tank as the master controller. This will reduce system down time while the master controller tank receives servicing. Since the redundant tank operates the least in a multi-tank system, it is the tank most likely to remain online.
- Match the capacity of the redundant tank to the largest tank in the system to ensure the system's ability to meet maximum humidification load when a tank goes offline.

See Note 1 in Table 79-1.

Tank grouping to maximize efficiency

Priority 1 and priority 2 tanks can be grouped to improve efficiency. Tanks not identified as trim or redundant tanks are factory-assigned to priority groups 1 and 2. Priority 1 tanks come online before priority 2 tanks. Because tanks in a multi-tank system can vary by capacity, this allows tank grouping to maximize efficiency, bringing tanks online in the order that best matches humidification load to individual tank capacity.

Example 1:

A large-capacity tank that meets humidification demand most days is assigned to priority group 1.

Smaller-capacity tanks, needed only when additional capacity is needed, are assigned to priority group 2.

Example 2:

A gas-fired tank that meets humidification demand most days is assigned to priority group 1.

Electric tanks, needed only when additional capacity is needed, are assigned to priority group 2.

Note: Wear leveling occurs only within a priority group.

Redundant tank for mission-critical applications

A redundant tank can be assigned for mission-critical applications. The system capacity of a multi-tank group is the combined capacity of tanks in groups 0, 1, and 2. Placing a tank in priority group 3 ensures that it only runs as a redundant tank. The redundant tank can be assigned to priority group 3 and will operate only if one or more of the tanks in groups 0, 1, and 2 are not available, **and** the remaining tanks in the multi-tank group cannot meet demand for steam production.

Note: For best performance, multiple electric humidifiers in a given priority group must all have the same heater controls. That is, they should all be 100% SSR control, or all be sequenced SSR control, or all be contactor control.

Tank wear leveling

The master controller monitors tank wear and assigns steam production to tanks to equalize wear as much as possible within each priority group.

Fault tolerance

The master controller monitors tank status of all tanks in a multi-tank group periodically. If a tank goes offline or is not communicating (“No comm”) for a defined time period, the controller identifies that tank as unavailable and the system responds using other available tanks. If the master controller stops operating, the remaining slave tanks continue to run for a short time at the level they were last run, and then quit.

Multiple-tank operation: Priority groups

Table 79-1: Multitank priority groups application example			
Priority group	Assignment	Description	Application considerations
0	Trim	<ul style="list-style-type: none"> Provides humidification load “throttling,” this unit sees the small changes as demand changes. Generally, this should be one tank, and it should be relatively small. Generally, this tank should be an SSR-controlled electric resistive unit. 	An SSR-controlled electric resistive unit will provide the best control.
1	Load	<ul style="list-style-type: none"> Carries the bulk of the load; should be the most cost-effective fuel source. Only sees large-step changes if a trim tank is used. 	GTS and STS are the most cost effective, but any unit can be used.
2	Peak	<ul style="list-style-type: none"> Makes up the demand not met by trim + load. Does not run often, because it is needed in only the most demanding situations. Because it does not run frequently (making fuel cost less of an issue), this is a good assignment for a lower-up-front-cost humidifier. Run time is a function of load percentage split into the peak category. 	Electric resistive are the most cost effective (any unit can be used).
3	Redundant	<ul style="list-style-type: none"> Provides the capability to offset a tank that is offline for any reason. This tank will only run when a trim, load, or peak unit is shut down for service or alarm conditions and the remaining trim, load, and peak tanks cannot meet demand. The redundant should be as large as the largest tank in the system. See Note 1 below. If a redundant tank is used, making it the master controller improves system uptime, since you will not need to bring down the master controller to service it. 	<ul style="list-style-type: none"> Electric humidifiers are the most cost-effective up front. Size should be the determining factor. Any unit will work.
<p>Notes:</p> <ol style="list-style-type: none"> If protection is required against multiple tanks being offline at the same time, the redundant tank should be at least as large as the sum of the X largest tanks where X is the number of tanks for which protection is desired. From a fuel cost standpoint, electric should have the lowest priority. It should run last and the least. From an energy standpoint, GTS generally has the lowest operating cost. When calculating energy, consider heat loss from distribution and piping of steam. Humidifiers within a priority group are load leveled. Humidifiers within a group should have the same energy source. 			

Multiple-tank operation: Wiring and setup

Important:

All multi-tank communication must go through the master controller to reach slave tanks. Therefore, keypad/display communication requires that power is supplied to:

- The master controller (on Tank A)
- Any other tank that is hosting the keypad/display

Wiring a multi-tank group of humidifiers

To wire a multi-tank group of humidifiers:

1. Determine which control board is the master controller. The master controller ships with the keypad/display. The master controller is labeled as Tank A on the keypad/display and on the tank's product label.
2. Connect all required control inputs to the master controller board by following the instructions in "Control input" on Page 12.
3. Wire all control boards of the multi-tank group together using twisted pair wire.

Important: DRI-STEEM recommends using Cat-5 cable. Do not use non-twisted two-conductor wire.

Connect controller boards together at terminal block P8.

Connect positive to positive terminals, and negative to negative terminals. On the last board in the series of connected boards, change the switch labeled "SW1" (located on the Vapor-logic4 board next to P8) to the On position. On all other boards SW1 should be in the Off position.

4. If you plan to use the Web interface, follow the wiring instructions in "Web interface communication" on Page 21.

Note: Each tank must be connected via Ethernet to a network system for the Web interface to access all tanks in the multi-tank group.
5. Connect the keypad/display cable to any control board in the multi-tank system. The master tank must be powered for the display to communicate.

Multi-tank system setup

Factory configuration

Humidifier tanks ordered as a multi-tank group are configured at the factory. The factory configuration process includes:

- Assigning letter names to tanks (Tank A, Tank B, ..., Tank P).

Note: The master tank is always configured as Tank A.
- Assigning priority group numbers (0, 1, 2, 3)
- Configuring the controllers

Changing factory configuration

Change tank designation using the Web interface only. Go to the Web screen Setup menu to access Multi-tank setup/Tank designator.

Important:

Any change made to or from the tank controller designated as "A" will cause an approximate five-second delay while the board reboots. During this time the Web interface display will not change.

Multiple-tank operation: Modbus, BACnet, LonTalk

To change a priority group, go to the Setup menu to access Multi-tank setup/Tank priority group.

To add a tank to a multi-tank system:

1. Verify that the new tank has the correct tank designator. Change, if necessary, before wiring in Step 2.
2. Connect wiring of new tank.
3. The master controller automatically adds the new tank's capacity into the total system capacity.

To permanently remove a tank from a multi-tank system:

1. Disconnect control board wiring (location P8) of the tank being removed.
2. Reset system capacity from the Multi-tank setup menu. The controller will automatically calculate the new system capacity.

Important:

- Each tank in a multi-tank system must have a unique tank designator (A, B, C ... P). Duplicate tank designations will cause multi-tank mode to operate incorrectly.
- Each Vapor-logic4 board ships with a network IP address of 192.168.1.195. When installing on an Ethernet network, assign each board a unique IP address to avoid conflict with other devices on the network.

Other system parameters and interoperability

General system parameters are set the same as for stand-alone tank/controller. See the Setup section of this manual for instructions.

Multi-tank operation with Web interface

If you plan to use the Web interface for multi-tank operation, the web interface must first be configured, see *Web interface communication* on Page 21.

Table 81-1: Multi-tank fieldbus profiles					
Item	Description	Modbus register	BACnet	BACnet description	LonTalk
MT_ACTIVE_FAULT_EXISTS_SOMEWHERE	TRUE when there is an active fault on 1 or more units in the MT group	DI:10 10010	BI-08	MT_active_fault_in_system	nvoMT_AlarmSomewhere
MT_ACTIVE_MESSAGE_EXISTS_SOMEWHERE	TRUE when there is an active message on 1 or more units in the MT group	DI:11 10011	BI-09	MT_active_message_in_system	nvoMT_MsgSomewhere
MT_SYS_OUTPUT_MASS_HR	Actual steam production of the system (mass/hr)	IR:23 30023	AI-08	MT_steam_demand_mass	nvoMT_SteamOutMass
MT_SYS_OUTPUT_LBS_HR	Actual steam production of the system (lbs/hr)	IR:24 30024			
MT_SYS_OUTPUT_PCNT	Actual steam production of the system (% of system capacity)	IR:25 30025	AI-09	MT_steam_demand_percent	nvoMT_SteamOutput%
MT_RUNMODE	MT runmode 1=run, 0=standby	HR:14 40014	MSV-02	MT_Runmode values: 1)System Standby 2) System Auto	nviMTRunMode nvoMTRunMode
MT_STEAM_REQ_MASS_HR	The fieldbus request for steam (lbs/hr)	HR:15 40015	AV-14	MT_steam_output_req_mass	nviMT_FbusDemndMass
MT_STEAM_REQ_LBS_HR	Fixed units. The fieldbus request for steam (lbs/hr)	HR:16 40016			
MT_STEAM_REQ_SYS_PCNT	The fieldbus request for steam (% of system)	HR:17 40017	AV-15	MT_steam_output_req_pcnt	nviMT_FldBusDemand%

Multiple-tank operation: Using the keypad/display

The keypad/display can communicate with every humidifier tank's controller in a multi-tank group. When a multi-tank group is operating normally, the keypad/display shows the Master screen. See the screens below for information about display screens in a multi-tank system.

Master screen →

SPACE RH	SET PT	
20%	35%	
MASTER	OUTPUT	
	0%	
MODE: SysAuto		
MAIN	MESSAGE	ALARM

Main Menu screen →

Select Multitank status →
to view other tanks in a multitank system (other menu items refer to Tank A on this screen).

MAIN MENU	1/5	A
Multitank status		
Tank status		
Diagnostics		
Alarms		
Tank setup		
	HOME	

Multitank Status screen →

Select MT Master →
to view the Master screen (shown below). Select A, B, or C, etc., to view other tanks in the system.

MULTITANK	1/17	A
MT Master		
A	Cold	
B	<No comm>	
C	<No comm>	
D	<No comm>	
	HOME	BACK

Tank A screen →

Note here that Tank A has 0% output because it is not yet at boiling temperature.

SPACE RH	SET PT	116°F
20%	35%	
TANK A	OUTPUT	
	0%	
MODE: Auto		Warm
MAIN	MESSAGE	ALARM

Multiple-tank operation: Using the Web interface

Additional Web interface screens, described below, appear when operating in multi-tank mode.

DRISTEEM Vapor-logic4

STATUS ALARMS DIAGNOSTICS **SETUP** HELP

System Status
 DEMAND 0% OUTPUT 0%
 SYSTEM RUN MODE System auto
 Tank Status
 DEMAND 0% OUTPUT 0%
 RUN MODE Drain tank
 TANK STATUS Draining

System Links
 Tank A
 Tank B

Alarms
 0 active alarms
 > View Alarms

Messages
 0 active messages
 > View Messages

Thursday, December 10, 2009 1:59:48 PM Data stream is LIVE
 View all humidifier settings below. Some settings can be changed here. Go to the Setup tab to change settings that cannot be changed from this page.

A TANK STATUS:

System run mode	System auto	CHANGE
Loading...	Drain tank	CHANGE
Input signal	0.8 VDC	
Steam output	0%	
Steam production	0 lbs/hr	
Duct HL switch	Closed	
Tank temperature	180°F	
Tank temp signal	1568 Ohms	
High water probe	Water	
Mid water probe	Water	
Low water probe	Water	
Low water sensor	Water	
Fill valve	Closed	
Drain valve	Open	
Surflow switch	Flow	
Interlock switch	Closed	
H2O until drain/flush	24856 lbs	
H2O until service	149819 lbs	
Blower 1 tach	0 rpm	
Gas Valve 1	Closed	
Combust air switch	Flow	
Power vent switch	Closed	
Flue pressure switch	Closed	
High probe signal	4	
Mid probe signal	2	
Low probe signal	3	

Each connected tank automatically shows up as a link. Click on a tank link to view its status.

Important: All system tanks must be network-connected via Ethernet for these links to function.

DRISTEEM Vapor-logic4

STATUS ALARMS DIAGNOSTICS **SETUP** HELP

System Status
 DEMAND 0% OUTPUT 0%
 SYSTEM RUN MODE System auto
 Tank Status
 DEMAND 0% OUTPUT 0%
 RUN MODE Drain tank
 TANK STATUS Draining

System Links
 Tank A
 Tank B

Alarms
 0 active alarms
 > View Alarms

Messages
 0 active messages
 > View Messages

Thursday, December 10, 2009 2:00:44 PM Data stream is STOPPED START LIVE DATA
 Set or change all humidifier settings below. Humidifiers are sent from the factory configured as ordered. However, some settings are unknown at the factory and need to be defined on this page.

SETUP

- + INPUT SIGNAL
- + LIMIT CONTROLS
- + WATER TYPE
- + WATER MANAGEMENT
- + FAN-BASED DISPERSION
- + REMOTE TEMP SENSOR
- + COMMUNICATIONS
- + PROGRAMMABLE OUTPUTS
- + SET DATE AND TIME
- + LANGUAGE
- + UNITS
- + SECURITY
- + CAPACITY ADJUST
- + RESET TO DEFAULTS
- MULTITANK SETUP

Tank priority group	2	CHANGE
Tank designator	A	CHANGE
Total system capacity	226 lbs/hr	CHANGE

Click on the Setup tab to view Multi-tank setup parameters.

Troubleshooting guide

DRI-STEEM Technical Support:
800-328-4447

Solving issues

1. Review issues, possible causes and recommended actions.

The troubleshooting guide on the following pages presents issues, possible causes and recommended actions for typical issues.

2. Review tank or dispersion manuals.

If you have a tank-related or dispersion-related issue, you may also need to refer to those specific product manuals.

3. If you're still having issues, call DRI-STEEM.

If the troubleshooting guide does not help you solve your issue, call DRI-STEEM with the following information available:

- Product name and serial number
You'll find this information on the humidifier or control cabinet.
- Issue definition
Example: water leaking, low humidity, high humidity, etc.
- Alarms or Messages Log items (if applicable)
Example: Tank temp, probe wiring, etc.
- Time issue began
Example: Always, after remodel, after a change in weather, etc.
- System changes
Example: Pressure, new boiler, new service, new controller, relocation, change in maintenance, etc.

Calling DRI-STEEM Technical Support

Have the following information ready before calling:

Vapor-logic4 firmware version _____

Humidifier model number _____

Humidifier serial number _____

Issue definition _____

Alarms Log items _____

Messages Log items _____

Time issue began _____

Recent system changes _____

Troubleshooting guide

Table 85-1: Troubleshooting guide			
	Issue	Possible causes	Actions
Power issues	Green power indicator light is off.	• No control voltage	• Check for proper supply voltage.
		• Heater fuses open	• Check heater fuses for voltage present at transformer.
		• Transformer secondary circuit breaker tripped	• Check for wiring shorts; reset breaker.
	No remote indication of alarm light No remote activation of fan	• Dry contact or triac connection not programmed from Setup menu	• Go to the programmable outputs section of Setup menu to program dry contact and/or 24 VAC triac.
		• Field wiring not installed	• Provide field wiring to a remote fault indicator from the dry contact connection point on terminal block P12 or from the triac connection point on terminal block P16.
		• Field-supplied remote fault indicator lamp is burned out	• Check if at remote indicator light is burned out; replace if needed.
		• Remote fault Vapor-logic4 dry contact is not switching	• Check dry contact continuity (Vapor-logic4 terminal P12) for contact closure.
	No readable information on keypad/display	• No power or incorrect voltage to Vapor-logic4 board	• Check main power supply. • Reset control transformer circuit breaker if tripped. • Reset thermal cutout if tripped. • Low limit thermostat is not satisfied (outdoor enclosure only).
		• Modular communication cable is disconnected	• Connect modular cable.
	Keypad/display does not energize.	• Nonexistent supply voltage to unit	• Check main fuse. • Check main line safety switches. • Check heater fuses.
		• Nonexistent 24 VAC supply	• Check for proper supply. • Verify proper transformer voltage characteristics. • Verify proper wiring of transformer. • Check for control circuit voltage, 24 VAC. If voltage is not present, check transformer circuit breaker. Reset if needed.
		• Humidifier over-temperature thermostat open	• Reset manual switch located above heater below terminal cover.
	Display is completely black.	• Keypad/display is overheated	• Cool the keypad.
		• Communication cable not connected	• Connect cable.
		• Defective cable	• Replace cable.
• Defective keypad		• Replace.	
• Defective control board		• Contact DRI-STEEM.	

Continued

Troubleshooting guide

**Table 85-1:
Troubleshooting guide (continued)**

	Issue	Possible causes	Actions
Transmitter or humidistat issues	Alarm: RH signal out of range	When transmitter or humidistat alarms appear, possible causes are: <ul style="list-style-type: none"> • Open, shorted, or incorrect wiring • Incorrect signal • Ground loop • Signal exceeds range limits. Correct input signals are: 4-20 mA, or 0-10 VDC 	<ul style="list-style-type: none"> • Check voltages at board terminals. <ul style="list-style-type: none"> <u>At terminal P11</u> <ul style="list-style-type: none"> -- RH signal: 2-10 VDC. -- Dew point signal: 2-10 VDC. -- Demand signal: 0-10 VDC. <u>At terminal P13</u> <ul style="list-style-type: none"> -- Duct high limit signal: 0-24 VDC, 2-10 VDC. <u>At terminal P14</u> <ul style="list-style-type: none"> -- Auxiliary temp sensor or temperature compensation sensor: 2-10 VDC. • Check output on transmitter: <ul style="list-style-type: none"> -- If there is no output, replace transmitter. -- Verify output is 4-20 mA. -- Calibrate transmitter or humidistat if necessary. • Isolation control board by others may not be compatible. Consult DRI-STEEM.
	Alarm: Dew point signal out of range		
	Alarm: Demand signal out of range		
	Alarm: Duct RH signal out of range		
	Alarm: Aux temp sens out of range		
	Alarm: No SDU airflow	• SDU blower or airflow proving switch is incorrectly wired	• Check SDU for proper wiring.
• SDU blower cover is off		• Install cover.	
• SDU blower motor is inoperable (SDU fan does not start)		• Replace SDU blower.	
• Breaker tripped		• Reset breaker.	

Continued

Troubleshooting guide

**Table 85-1:
Troubleshooting guide (continued)**

	Issue	Possible causes	Actions
Water level control probe issues	Alarm: Water probe miswired Alarm: Faulty water probe	<ul style="list-style-type: none"> • Incorrect installation 	<ul style="list-style-type: none"> • Verify proper wiring of probe system. Do not use shielded (screened) wiring. • Verify probe wiring is not routed with high voltage wiring. • Verify wiring between control cabinet and humidifier does not exceed the recommended 50' (15 m) limit. • Verify fill and drain plumbing was installed per the instructions in the humidifier's manual. • Verify piping from the humidifier to the dispersion assembly is installed correctly, that there are no elbows or restrictions in the piping, and that the length of the piping is not too long. See instructions in the humidifier's manual. • Verify there is a P-trap installed on the tank and/or that the P-trap is not plugged. • Verify that there is a machine ground between control cabinet and humidifier tank.
		<ul style="list-style-type: none"> • Dirty or oxidized probes 	<ul style="list-style-type: none"> • Clean probe, removing oxidation and/or minerals or replace if needed. • Drain tank water to below the probe; reset system and restart.
		<ul style="list-style-type: none"> • Deterioration of probe rod assembly 	<ul style="list-style-type: none"> • Replace probe rod assembly.
		<ul style="list-style-type: none"> • Low conductivity water supply 	<ul style="list-style-type: none"> • If conductivity is less than 30 $\mu\text{S}/\text{cm}$ add 1/4-1/2 tab sodium bicarbonate (i.e., Alka Seltzer) to increase conductivity. Consult DRI-STEEM for further advice.
		<ul style="list-style-type: none"> • Humidifier interlock switches and/or over-temperature thermostat 	<ul style="list-style-type: none"> • Verify that switch or thermostat is wired. • Verify interlock switch is set correctly and humidifier cover is on. • Reset over-temperature thermostat if tripped.
		<ul style="list-style-type: none"> • Missing probe rod 	<ul style="list-style-type: none"> • Replace missing probe rod if possible; otherwise, replace probe assembly.

Continued

Troubleshooting guide

**Table 85-1:
Troubleshooting guide (continued)**

Issue	Possible causes	Actions	
Filling issues	Alarm: Excessive fill time	Tank is not full.	
		<ul style="list-style-type: none"> • Fill and drain valve wiring reversed • Low water supply pressure • In-line strainer plugged • Humidifier cover interlock switch improperly wired • Fill valve not open • Fill valve not wired properly to control board • Inlet water needle valve closed or plugged • Fill valve with incorrect operating voltage • Plugged fill valve • Fill valve installed backward • Excessive water hammer can bend a needle valve and make it difficult to open • Orifice after fill valve may be plugged • Drain valve leaking water • Missing probe rod 	
	Alarm: Excessive refill time		<ul style="list-style-type: none"> • Correct wiring. • Verify water pressure is 25 psi (552 kPa) minimum. • Clean as needed. • Correct wiring. • If 24 VAC is present across fill valve coil, replace valve. • Verify proper fill valve wiring at terminal P17 (fill, drain). • Test operation by going to the Test section under the Diagnostics menu. • Check if needle valve is open and free of sediment. • Verify valve coil is 24 VAC. • Remove fill valve and check for foreign material plugging the valve. • Check arrow direction on valve; or "In" should be visible on fill valve body. • Replace valve, if needed. • Install a water supply line shock arrester. • Service valve strainer and orifice assembly. • Verify drain is in the Auto position and is closed. • Replace missing probe rod if possible; otherwise, replace probe rod assembly.
		Tank is full.	
		<ul style="list-style-type: none"> • Probe malfunctioning 	<ul style="list-style-type: none"> • Clean or replace probe.
		<p>Low water conductivity:</p> <ul style="list-style-type: none"> • Tap/softened water GTS humidifiers and electric humidifiers with heating elements require fill water conductivity to be 30 µS/cm minimum. • XT humidifier recommended fill water conductivity is 125 to 1250 µS/cm. 	<ul style="list-style-type: none"> • Add add ¼-½ tab sodium bicarbonate (i.e., Alka Seltzer) to increase water conductivity. Consult DRI-STEEM for further advice.
		<ul style="list-style-type: none"> • No tank ground 	<ul style="list-style-type: none"> • Install tank ground.
		<ul style="list-style-type: none"> • Fill valve stuck open 	<ul style="list-style-type: none"> • Check valve for foreign matter.
		<ul style="list-style-type: none"> • Fill valve installed backward 	<ul style="list-style-type: none"> • Check arrow direction on valve; or "In" should be visible on fill valve body.
		<ul style="list-style-type: none"> • Excessive condensate is draining into the tank 	<ul style="list-style-type: none"> • Consult DRI-STEEM to increase the amount of water that can be converted to steam before receiving a fault.
		For XT humidifiers, see <i>Check cylinder / high water</i> on Page 47 of Table 45-1.	
		<ul style="list-style-type: none"> • Malfunctioning level control system 	<ul style="list-style-type: none"> • If needed, clean probes. • Check water conductivity. Minimum conductivity for proper operation of level control system is 30 µS/cm. • Verify that probe wiring is correct.
		<ul style="list-style-type: none"> • Drain valve not fully closed 	<ul style="list-style-type: none"> • If an obstruction does not allow drain valve to fully close, clean valve. • If there is a broken or weak return spring on drain valve, replace the valve. • Check if 24 VAC is present at valve. If so, check wiring of Vapor-logic4 control board terminal P17 (drain).
		<ul style="list-style-type: none"> • Poor tank ground 	<ul style="list-style-type: none"> • Verify good machine ground.

Continued

Troubleshooting guide

**Table 85-1:
Troubleshooting guide (continued)**

	Issue	Possible causes	Actions
Filling issues	Unit does not fill with water.	<ul style="list-style-type: none"> Malfunctioning fill valve 	<ul style="list-style-type: none"> Unplug probe head. Fill valve should open. If fill valve does not open, verify proper 24 VAC to fill valve. If voltage is present and valve does not open, replace valve or valve coil. Verify that coil is 24 VAC. Verify that valve stem moves freely.
		<ul style="list-style-type: none"> No water supply to fill valve 	<ul style="list-style-type: none"> Check if water supply line strainer is plugged. Verify that manual water line shut-off valve is open and that pressure exists. Check that in-line needle valve is open.
		<ul style="list-style-type: none"> Unit is not in Auto Mode 	<ul style="list-style-type: none"> Change mode to Auto.
		<ul style="list-style-type: none"> Vapor-logic4 control is in end-of-season drain mode 	<ul style="list-style-type: none"> Check for humidification demand signal at control board.
		<ul style="list-style-type: none"> Inlet water needle valve is closed 	<ul style="list-style-type: none"> Check needle valve.
		<ul style="list-style-type: none"> Unit is in freeze protection draining 	<ul style="list-style-type: none"> Change mode to Auto.
		<ul style="list-style-type: none"> Fill valve stuck in closed position 	<ul style="list-style-type: none"> Recycle power to recycle fill valve closing and opening.
	<ul style="list-style-type: none"> Malfunctioning level control system 	<ul style="list-style-type: none"> See below. 	
	Fill valve does not close	<ul style="list-style-type: none"> Open drain valve 	<ul style="list-style-type: none"> If automatic drain valve is locked in the manual open position, reset to automatic. Replace valve if there is a broken return spring on the drain valve. Clean or replace drain valve if an obstruction in the valve does not allow complete closure. Close manual drain valve if it is open. If Vapor-logic4 shorted output to fill valve coil, replace board or drain coil.
		<ul style="list-style-type: none"> Malfunctioning level control system 	<ul style="list-style-type: none"> Check that probe plug is plugged in fully. If needed, clean probe rods. If water conductivity is too low (see below), add ¼-½ tab sodium bicarbonate (i.e., Alka Seltzer) to tank or cylinder water. If this solves the issue, you have low-conductivity water; consult DRI-STEEM for further advice. <ul style="list-style-type: none"> Tap/softened water GTS humidifiers and electric humidifiers with heating elements require fill water conductivity to be 30 µS/cm minimum. XT humidifier recommended fill water conductivity is 125 to 1250 µS/cm. Replace board if Vapor-logic4 control board is defective. Verify that system is in auto mode. Verify that probe is wired correctly.
<ul style="list-style-type: none"> Fill valve is stuck 		<ul style="list-style-type: none"> Check if fill valve is installed backwards. If yes, repipe. If there is a faulty internal spring or diaphragm in the fill valve, replace valve. Check if there is an obstruction that does not allow valve to seat properly. Clean or replace valve as needed. Check for control voltage across fill valve coil. (Check wiring and controls.) Install water inlet shock arrestor. 	

Continued

Troubleshooting guide

**Table 85-1:
Troubleshooting guide (continued)**

	Issue	Possible causes	Actions
Draining issues	Alarm: Tank not draining	• Tank drain outlet	• If the humidifier tank drain outlet is plugged, clean.
		• Water detection probes	• Clean probe or replace probe rod assembly.
		• Drain valve wiring	• Check drain valve wiring. • Check to be sure drain valve is wired to Terminal P17 (drain) on control board. • Reset Vapor-logic4.
		• Fill valve	• Check for voltage present at the valve. If present, clean or replace valve. • Replace fill valve if water is leaking through.
		• System programmed for manual drain	• Run a test cycle to see if the system activates drain output.
		• Drain line backing up with water • Drain line plugged	• Insufficient drain line pitch. • Insufficient drain line size. See tank manual for drain piping size and pitch requirements.
	Unit does not perform automatic drain sequence	• Humidifier may not have automatic drain system, or automatic drain is disabled	• Inspect unit to verify that an automatic drain valve was furnished. • Go to Setup menu to verify that auto drain/flush is enabled.
		• Drain fault, plugged drain valve, or plugged drain pipe	• Clean drain valve piping.
		• Malfunctioning automatic drain sequence	• Go to Setup menu and check auto drain/flush settings.
		• No power to the automatic drain valve	• Check if 24 VAC is present at terminal block P17 (drain) and at drain valve.
	Unit does not perform end-of-season drain	• Defective automatic drain valve	• If voltage is present at the valve and it still does not open, replace valve.
		• Input signal always has a demand	• Reduce demand signal.
		• Vapor-logic4 setup	• Verify in Setup menu Vapor-logic4 is set for end-of-season drain.
• Drain valve		• Valve not wired, or incorrectly wired, to control board. • Check 24 VAC across valve coil during test cycle.	

Continued

Troubleshooting guide

**Table 85-1:
Troubleshooting guide (continued)**

	Issue	Possible causes	Actions
Heating issues	Alarm: Tank temperature sensor failed	<ul style="list-style-type: none"> Open, shorted, or incorrect wiring of sensor 	<ul style="list-style-type: none"> Check wiring terminals for correct wiring and voltages. 1000 Ohms = 68 °F (20 °C); 1702 Ohms = 212 °F (100 °C).
		<ul style="list-style-type: none"> Humidifier interlock switches and/or over-temperature thermostat 	<ul style="list-style-type: none"> Verify that switch or thermostat is wired. Verify interlock switch is set correctly and humidifier cover is on. Reset over-temperature thermostat if tripped.
	Alarm: Tank overtemp	<ul style="list-style-type: none"> Unit has overheated; temperature is at 25 °F (14 °C) over boiling temperature 	<ul style="list-style-type: none"> Check for proper water level in tank.
		<ul style="list-style-type: none"> Faulty sensor 	<ul style="list-style-type: none"> Replace sensor.
	Reduced or no output (even though water level is correct)	Electric humidifiers: <ul style="list-style-type: none"> Heater malfunctioning 	<ul style="list-style-type: none"> Verify that proper voltage is being applied to heaters. Verify heater amperage matches wiring diagram. If heater contactor is not functioning, replace.
		Electric humidifiers: <ul style="list-style-type: none"> Malfunctioning control system 	<ul style="list-style-type: none"> Check if heater fuses are blown and replace if required. Check if auxiliary limit controls are not allowing system to operate, e.g., duct humidistats, airflow proving switch, etc. Reset, replace or calibrate as needed. (Airflow switch, terminal P13 (24VAC and AFsw) measures 24 VAC if open. On-off high limit, terminals P13 (24VDC and DHL), measures 24 VDC if open. Check if the heater over-temperature thermostat has tripped. Reset if necessary.
		GTS, STS or LTS systems only: <ul style="list-style-type: none"> Dirty heat exchanger 	<ul style="list-style-type: none"> Clean.
GTS systems only: <ul style="list-style-type: none"> Dirty burners Low gas pressure 		<ul style="list-style-type: none"> Clean or adjust as appropriate. See tank manual for instructions. 	

Continued

Troubleshooting guide

**Table 85-1:
Troubleshooting guide (continued)**

	Issue	Possible causes	Actions
Heating issues	Heater burnout	<ul style="list-style-type: none"> Water level is too low 	<ul style="list-style-type: none"> Replace probes.
		<ul style="list-style-type: none"> Improper wiring 	<ul style="list-style-type: none"> Verify proper voltage applied to heater. Verify proper electrical connections.
		<ul style="list-style-type: none"> Mineral buildup on heaters 	<ul style="list-style-type: none"> The humidifier may be undersized. Increase humidifier capacity or replace with larger humidifier. Consult DRI-STEEM. Inspect tank for severe mineral buildup on or around heater. Increase skim duration, frequency of drain cycle, and/or frequency of cleaning. Use softened makeup water.
		<ul style="list-style-type: none"> Contactors failed to open 	<ul style="list-style-type: none"> Replace.
		<ul style="list-style-type: none"> SSR failed closed 	<ul style="list-style-type: none"> Replace SSR controller.
		<ul style="list-style-type: none"> Heater corrosion 	<ul style="list-style-type: none"> Inspect heater for surface corrosion or pitting. Before replacing burned-out heater verify chloride content in supply water is very low.
	Tank does not heat up.	<ul style="list-style-type: none"> Over-temperature thermostat switch located under heater wiring cover tripped 	<ul style="list-style-type: none"> Reset thermostat switch.
		<ul style="list-style-type: none"> Humidifier cover interlock switch (Vaporstream models only) 	<ul style="list-style-type: none"> Humidifier cover not wired; adjust interlock switch.
		<ul style="list-style-type: none"> Combustion air switch or power vent switch (GTS systems only) 	<ul style="list-style-type: none"> Check venting system and combustion dampers. Verify wiring and connections on switches are properly connected.
		<ul style="list-style-type: none"> Incorrect or nonexistent control voltage 	<ul style="list-style-type: none"> Check for proper supply voltage on electrical diagram. Verify proper transformer voltage characteristics. Verify proper wiring of transformer. Check for control circuit voltage on electrical diagram. If voltage is not present, troubleshoot boards and wiring system for potential short circuit.
		<ul style="list-style-type: none"> Incorrect or nonexistent supply voltage to the unit 	<ul style="list-style-type: none"> Check main line fuse. Check main line safety switch. Check heater fuses and wiring diagram.
		<ul style="list-style-type: none"> Duct RH above high limit set point 	<ul style="list-style-type: none"> Check for duct airflow. Verify operation of duct high limit switch or transmitter.
		<ul style="list-style-type: none"> No demand signal 	<ul style="list-style-type: none"> Check signal by others. Check for miswired connection. Verify in the Setup menu that humidifier is configured for demand signal.
		<ul style="list-style-type: none"> Humidifier is in Standby mode 	<ul style="list-style-type: none"> Change mode to Auto.
	Humidifier tank has proper water level and is always warm.	<ul style="list-style-type: none"> Aquastat 	<ul style="list-style-type: none"> This is normal; the aquastat is maintaining a certain tank water temperature within range of 40 °F to 180 °F (4 °C to 82 °C). Readjust aquastat temperature to a lower set point.
<ul style="list-style-type: none"> SSR power controller 		<ul style="list-style-type: none"> SSR control devices shorted closed; check/replace. Phase-to-phase wiring crossed. 	
<ul style="list-style-type: none"> Contactor 		<ul style="list-style-type: none"> Contactor shorted closed; replace. 	

Continued

Troubleshooting guide

**Table 85-1:
Troubleshooting guide (continued)**

Humidity set point issues	Issue	Possible causes	Actions
	Humidity is below desired level.	<ul style="list-style-type: none"> Unit is operating but fails to meet required humidity level 	<ul style="list-style-type: none"> Unit undersized; replace with a larger unit or add additional humidifier. Skim duration is too long. If drain valve does not close fully, determine the cause and clean, repair, or replace as needed. If drain pipe water seal is allowing steam to go down the drain, fill P-trap with water or repair as needed. If there is an improper water seal height, increase to the recommended height (see humidifier tank manual for water seal height). If there is excessive internal steam pressure, determine the cause of the high pressure (e.g., high duct static pressure, undersized orifices in dispersion tubes, water, or crushed vapor hose) and correct as required. Replace leaking gasket or vapor hose. Recalibrate if controls are out of calibration. If fill valve is stuck open, repair or replace. If zone valve will not open, repair or replace.
		<ul style="list-style-type: none"> No call for humidity from humidistat or from control and high limit humidity transmitters 	<ul style="list-style-type: none"> Interconnecting steam piping to the dispersion assembly is too long and/or uninsulated (do not insulate steam hose). Low or no signal strength from humidistat. Check for proper wiring. Check humidity transmitters (4 to 20 mA output). Adjust set point if RH or dew point set point is too low.
		<ul style="list-style-type: none"> Excessive outside air volume 	<ul style="list-style-type: none"> Verify proper operation of fans, dampers, VAV systems, etc.
		<ul style="list-style-type: none"> Heating elements not operating 	<ul style="list-style-type: none"> Verify that humidistat is calling for humidity. Check for control voltage if limit controls (airflow proving switch, zone valves, etc.) are not allowing unit to operate. Check fuses and replace if they are blown. Check if the heater over-temperature has been tripped. Reset if necessary.
		<ul style="list-style-type: none"> Humidity control input type not the same as Vapor-logic4 firmware Vapor-logic4 not in Auto mode 	<ul style="list-style-type: none"> Check Vapor-logic4 control board connections P11 and P13. Consult DRI-STEEM. Change mode to Auto.

Continued

Troubleshooting guide

**Table 85-1:
Troubleshooting guide (continued)**

	Issue	Possible causes	Actions
Humidity set point issues	Humidity above set point.	• High entering relative humidity	• Dehumidify.
		• Unit oversized	• Consult DRI-STEEM.
		• Reduced airflow	• Check fans, dampers, VAV systems, etc.
		• Improperly located humidistat or humidity transmitters	• Relocate, using guidelines in Appendix section of this manual.
		• Malfunctioning controls	<ul style="list-style-type: none"> • Check for incorrect supply voltage. • Check for incorrect control signal. • Check for improper wiring hookup. • If humidity controller or transmitter are out of calibration or malfunctioning, repair or recalibrate. • Check if SSR/contactor shorted. Repair or replace as needed.
	• Contactor/SSR is stuck closed	• Remove power from humidifier immediately. Contact DRI-STEEM.	
	Hunting (humidity swings above and below desired set point)	• Malfunctioning control system	<ul style="list-style-type: none"> • If there is a faulty or inaccurate humidity controller or transmitter, repair or replace. • Check for proper Vapor-logic4 control settings: RH set point, high limit set point, cycle rate, PID tuning, etc. • Relocate poorly located control components. See "Sensor placement" on Page 26. • On SSR units: Control wire and power wires must be physically separated from each other. If they are not, an induced control voltage can occur, causing erratic operation. • Verify that keypad/display modular cable is isolated from power wiring.
		• Air volume varies rapidly	• Stabilize.
		• Air temperature is varying rapidly	• Stabilize to ± 1 °F (± 1 °C).
		• Proportional band is too small and/or integral gain (Ki) is too large	<ul style="list-style-type: none"> • If RH swings outside PID band, increase PID band using the Setup menu. • Decrease integral gain (Ki) using the Set Up menu.
• On-off control is not adequate		• If controlling the humidifier with an on-off signal, consider changing to controlling with a modulating signal.	

Continued

Troubleshooting guide

**Table 85-1:
Troubleshooting guide (continued)**

	Issue	Possible causes	Actions
Gas-to-steam (GTS) humidifier issues	Alarm: Blocked flue	<ul style="list-style-type: none"> Blocked flue sensor is open 	<ul style="list-style-type: none"> Check venting system for obstructions. Check air line to flue switch for obstructions. Windy conditions cause downdrafts in venting system. Install a high wind vent cap or isolate as recommended by local codes.
	Alarm: Gas valve [number] fault	<ul style="list-style-type: none"> Failed ignition module Miswired gas valve 	<ul style="list-style-type: none"> Check ignition module. Replace if necessary. Check gas valve wiring.
	Alarm: Burner [number] fault	<ul style="list-style-type: none"> No gas supply to unit 	<ul style="list-style-type: none"> Verify that gas service valve is on and receiving minimum pressure to manifold per rating plate.
		<ul style="list-style-type: none"> Gas valve is off or there is no power to the valve 	<ul style="list-style-type: none"> Check for 24 VAC from the ignition module to the gas valve. Check that gas valve plug is seated properly.
		<ul style="list-style-type: none"> Broken ignitor 	<ul style="list-style-type: none"> Verify that ignitor glows. Replace if necessary.
		<ul style="list-style-type: none"> Gas valve outlet pressure is too low 	<ul style="list-style-type: none"> Verify outlet pressure is set per rating plate.
		<ul style="list-style-type: none"> Blower inlet is dirty or obstructed 	<ul style="list-style-type: none"> Clean inlet and check for obstructions.
		<ul style="list-style-type: none"> Flame sensor not sensing flame 	<ul style="list-style-type: none"> Check flame sensor wiring. Check polarity at incoming power. Switch if necessary. Stray fiber from burner touching flame sensor. Use a screwdriver to gently push down fibers near flame sensor. Flame sensor is cracked. Replace.
	Alarm: Ignition module [number] fault	<ul style="list-style-type: none"> Ignition sequence engaged without power to gas valve 	<ul style="list-style-type: none"> Verify ignition sequence. Replace ignition module.
		<ul style="list-style-type: none"> Gas valve/ignite/sensing electrode is out of sequence 	<ul style="list-style-type: none"> Verify wire connections to these components.
Alarm: Blower [number] fault	<ul style="list-style-type: none"> The blower is incorrectly wired, or the blower failed to meet demand speed 	<ul style="list-style-type: none"> Check for proper blower wiring. Replace blower. 	
Alarm: No power vent airflow	<ul style="list-style-type: none"> The power venter air flow switch is open 	<ul style="list-style-type: none"> Check for proper power vent wiring. Repair or replace power venter. 	
Alarm: No combustion airflow	<ul style="list-style-type: none"> The combustion air damper is open 	<ul style="list-style-type: none"> Check for proper combustion air damper wiring. Repair or replace damper motor. 	
Steam-to-steam (STS) humidifier issues	Humidifier will not heat	<ul style="list-style-type: none"> Steam stop valve closed 	<ul style="list-style-type: none"> Verify valve is open.
		<ul style="list-style-type: none"> Steam trap plugged 	<ul style="list-style-type: none"> Clean trap body.
		<ul style="list-style-type: none"> Steam strainer plugged 	<ul style="list-style-type: none"> Clean strainer.
	Low output	<ul style="list-style-type: none"> Low supply steam pressure 	<ul style="list-style-type: none"> Check steam supply pressure. Provide steam pressure as specified on unit.
<ul style="list-style-type: none"> Steam valve inoperable 		<ul style="list-style-type: none"> Valve not opening fully. Check signal to valve. 	
<ul style="list-style-type: none"> Steam trap blocked 		<ul style="list-style-type: none"> Trap not passing condensate. 	
<ul style="list-style-type: none"> Scale coated heat exchanger 		<ul style="list-style-type: none"> Clean heat exchanger. 	

Replacement parts

Table 96-1: Vapor-logic4 replacement parts		
Description	Quantity	Part number
Main board	1	408495-001
Keypad/display (includes printed circuit board, LCD display screen, membrane switch, front and back of plastic cover)	1	408495-010
Keypad/display communication cable (contact DRI-STEEM for lengths other than 27" (686 mm) and 60" (1524 mm))	27" (686 mm)	408490-014
	60" (1524 mm)	408490-009
Molex connector plug, 2-position	1	406246-002
Molex connector plug, 3-position	1	406246-003
Molex connector plug, 4-position	1	406246-004
LonTalk card	1	408642
BACnet	1	191515

Replacement parts

Figure 97-1:
Vapor-logic4 replacement parts

Main board

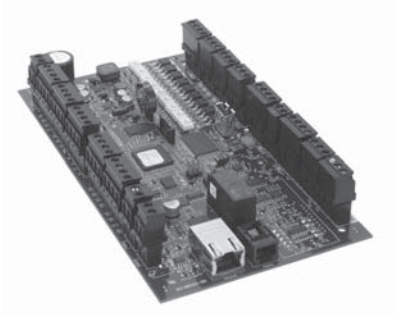

Keypad display



Molex connector plug (2-position shown)



LonTalk card

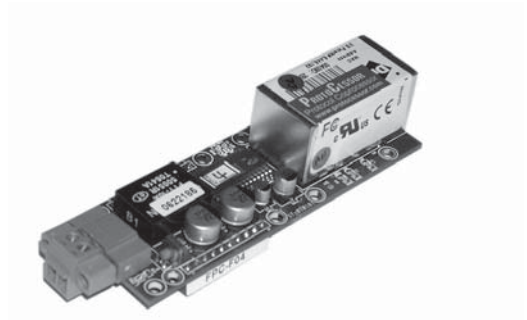

Expect quality from the industry leader

For more than 45 years, DRI-STEEM has been leading the industry with creative and reliable humidification solutions. Our focus on quality is evident in the construction of the Vapor-logic4 controller. DRI-STEEM also leads the industry with a Two-year Limited Warranty and optional extended warranty.

For more information

www.drsteem.com
sales@drsteem.com

For the most recent product information visit our website:
www.drsteem.com

DRI-STEEM Corporation

An ISO 9001:2000 certified company

European office:
Marc Briers
Grote Hellekensstraat 54 b
B-3520 Zonhoven
Belgium
+3211823595 (voice)
+3211817948 (fax)
E-mail: marc.briers@drsteem.com

U.S. Headquarters:
14949 Technology Drive
Eden Prairie, MN 55344
800-328-4447 or 952-949-2415
952-229-3200 (fax)

Continuous product improvement is a policy of DRI-STEEM Corporation; therefore, product features and specifications are subject to change without notice.

DRI-STEEM, Vaporstream, Vapormist, and Vapor-logic are registered trademarks of DRI-STEEM Corporation and are filed for trademark registration in Canada and the European community.

Product and corporate names used in this document may be trademarks or registered trademarks. They are used for explanation only without intent to infringe.

© 2012 DRI-STEEM Corporation

Firmware Version 2.X.X
Form No. VL4-IOM-M-0312
Part No. 890000-714 Rev C

Two-year Limited Warranty

DRI-STEEM Corporation (“DRI-STEEM”) warrants to the original user that its products will be free from defects in materials and workmanship for a period of two (2) years after installation or twenty-seven (27) months from the date DRI-STEEM ships such product, whichever date is the earlier.

If any DRI-STEEM product is found to be defective in material or workmanship during the applicable warranty period, DRI-STEEM’s entire liability, and the purchaser’s sole and exclusive remedy, shall be the repair or replacement of the defective product, or the refund of the purchase price, at DRI-STEEM’s election. DRI-STEEM shall not be liable for any costs or expenses, whether direct or indirect, associated with the installation, removal or reinstallation of any defective product. The Limited Warranty does not include cylinder replacement for electrode steam humidifiers.

DRI-STEEM’s Limited Warranty shall not be effective or actionable unless there is compliance with all installation and operating instructions furnished by DRI-STEEM, or if the products have been modified or altered without the written consent of DRI-STEEM, or if such products have been subject to accident, misuse, mishandling, tampering, negligence or improper maintenance. Any warranty claim must be submitted to DRI-STEEM in writing within the stated warranty period. Defective parts may be required to be returned to DRI-STEEM.

DRI-STEEM’s Limited Warranty is made in lieu of, and DRI-STEEM disclaims all other warranties, whether express or implied, including but not limited to any IMPLIED WARRANTY OF MERCHANTABILITY, ANY IMPLIED WARRANTY OF FITNESS FOR A PARTICULAR PURPOSE, any implied warranty arising out of a course of dealing or of performance, custom or usage of trade.

DRI-STEEM SHALL NOT, UNDER ANY CIRCUMSTANCES BE LIABLE FOR ANY DIRECT, INDIRECT, INCIDENTAL, SPECIAL OR CONSEQUENTIAL DAMAGES (INCLUDING, BUT NOT LIMITED TO, LOSS OF PROFITS, REVENUE OR BUSINESS) OR DAMAGE OR INJURY TO PERSONS OR PROPERTY IN ANY WAY RELATED TO THE MANUFACTURE OR THE USE OF ITS PRODUCTS. The exclusion applies regardless of whether such damages are sought based on breach of warranty, breach of contract, negligence, strict liability in tort, or any other legal theory, even if DRI-STEEM has notice of the possibility of such damages.

By purchasing DRI-STEEM’s products, the purchaser agrees to the terms and conditions of this Limited Warranty.

Extended warranty

The original user may extend the term of the DRI-STEEM Limited Warranty for a limited number of months past the initial applicable warranty period and term provided in the first paragraph of this Limited Warranty. All the terms and conditions of the Limited Warranty during the initial applicable warranty period and term shall apply during any extended term. An extended warranty term of an additional twelve (12) months or twenty four (24) months of coverage may be purchased. The extended warranty term may be purchased until eighteen (18) months after the product is shipped, after which time no extended warranties are available.

Any extension of the Limited Warranty under this program must be in writing, signed by DRI-STEEM, and paid for in full by the purchaser.

mc_051308_0630

